

A. MECHANICAL(unit:mm)

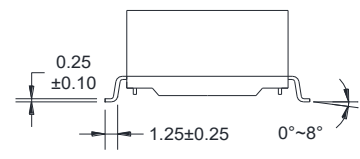

Suggested PAD Layout

B. SCHEMATICS

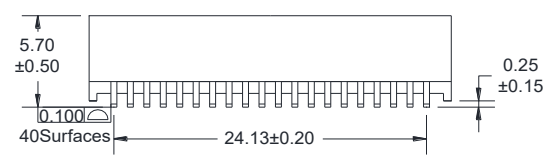
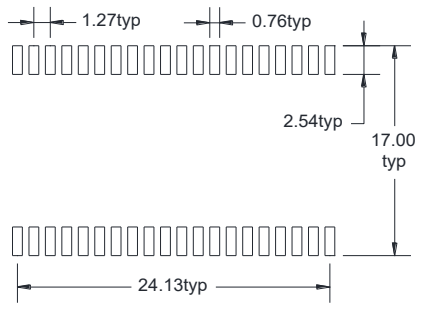
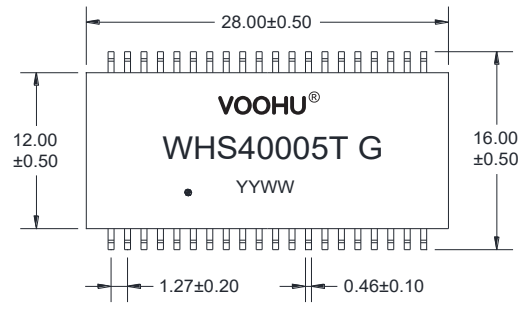
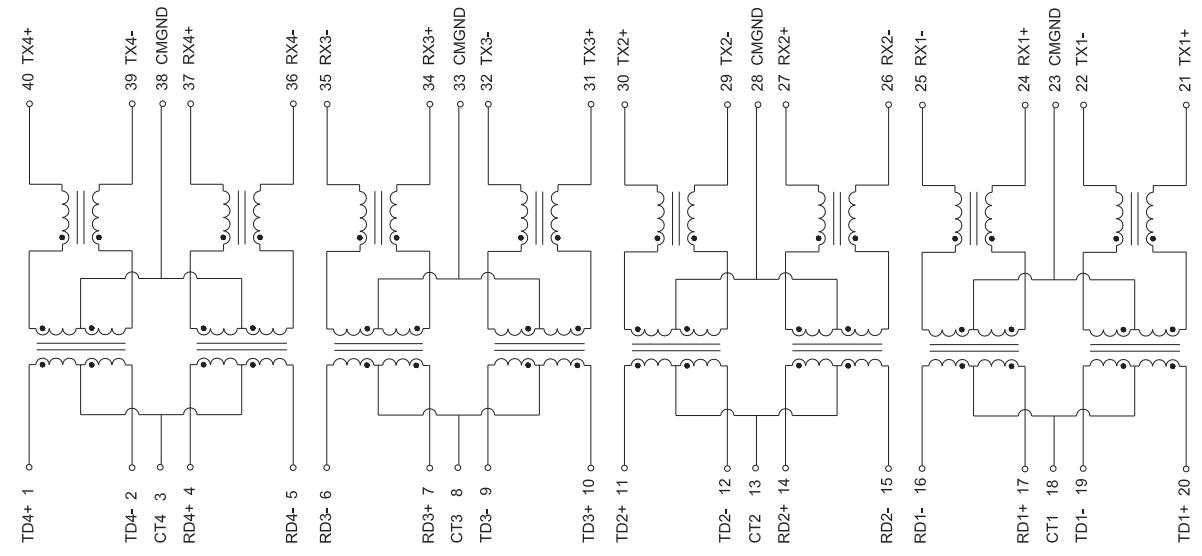

**VOOHU** 苏州沃虎电子科技有限公司  
Su Zhou Voohu Electronic Tech.Co.Ltd

TITLE: 10/100 BASE-TX	SIZE A4	UNITS MM[INCH]	GENERAL TOLERANCES UNLESS SPECIFIED		APPROVED BY: Geoffrey.Song
			x±0.35	x°±3.0°	
PART NO.: WHS40005T G	SACLE 1:1	REV A0	.xx±0.30	.x°±2.0°	CHECKED BY: Elvis.Song
			.xxx±0.10	.xxx°±1.0°	
REMARK:	SHEET 1/3		DESIGND BY: Sunny.Xu		

TEL: +86 400 1048 018

WEB: WWW.WOHU-TEK.COM

H  
G  
F  
E  
D  
C  
B  
A

H  
G  
F  
E  
D  
C  
B  
A



### E. RECOMMEND REFLOW SOLDERING CURVE

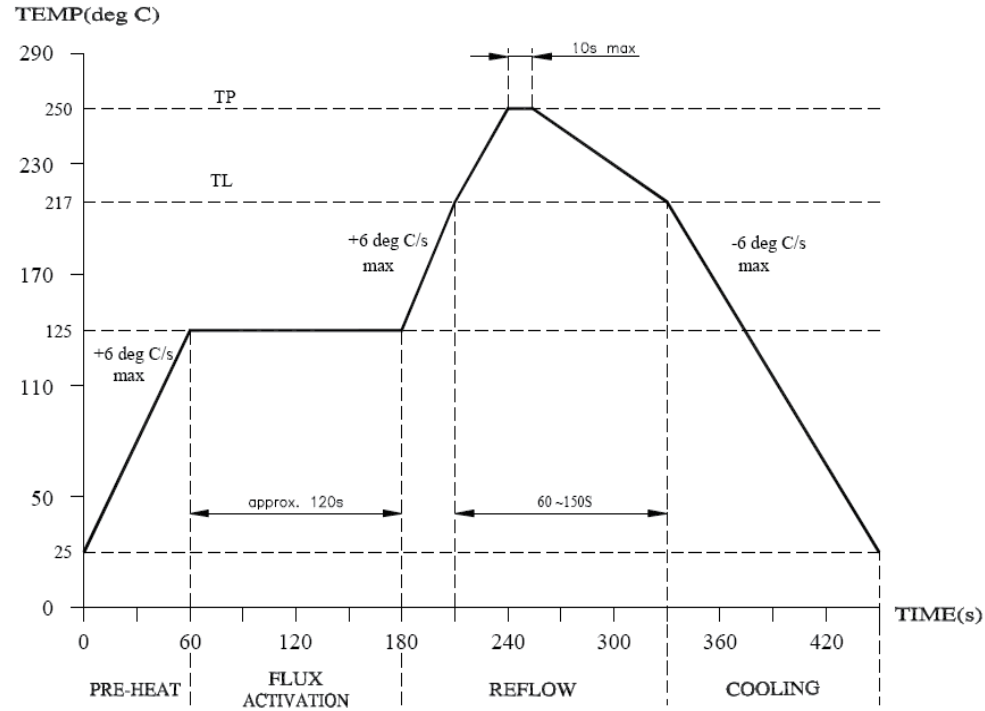

**VOOHU** 苏州沃虎电子科技有限公司  
Su Zhou Voohu Electronic Tech.Co.Ltd

TITLE:  
10/100 BASE-TX

SIZE  
A4

UNITS  
MM[INCH]

GENERAL TOLERANCES  
UNLESS SPECIFIED

APPROVED BY:  
Geoffrey.Song

PART NO.:  
WHS40005T G

SACLE  
1:1

REV  
A0

$x \pm 0.35$      $x^\circ \pm 3.0^\circ$   
 $.x \pm 0.30$      $.x^\circ \pm 2.0^\circ$

CHECKED BY:  
Elvis.Song

TEL: +86 400 1048 018

WEB: [WWW.WOHU-TEK.COM](http://WWW.WOHU-TEK.COM)

REMARK:

SHEET  
3/3

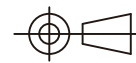

$.xx \pm 0.25$      $.xx^\circ \pm 1.5^\circ$   
 $.xxx \pm 0.10$      $.xxx^\circ \pm 1.0^\circ$

DESIGND BY:  
Sunny.Xu