

REACH & RoHS
COMPLIANT

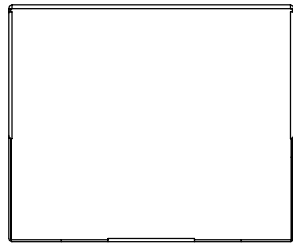

TOP VIEW

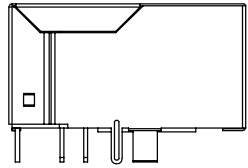

LEFT SIDE VIEW

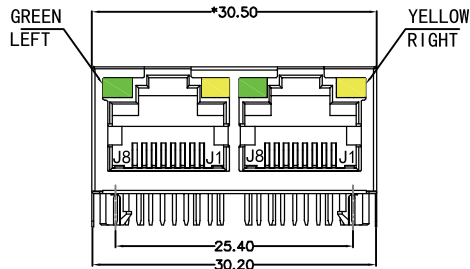

FRONT VIEW

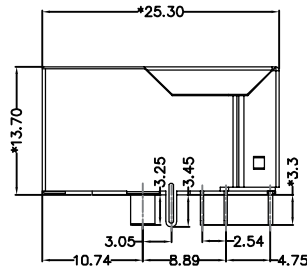

RIGHT SIDE VIEW

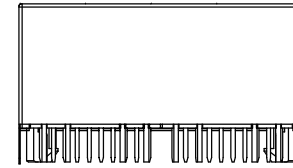

BACK VIEW

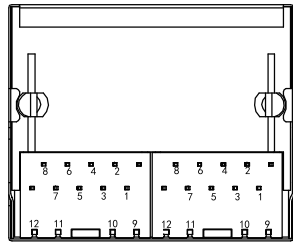

BOTTOM VIEW

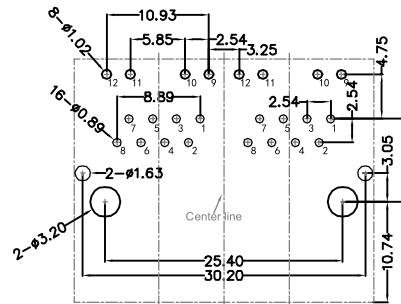

RECOMMENDED PCB LAYOUT
VIEWED FROM COMPONENT SIDE

MATERIAL:

HOUSING: PBT,UL94V-0,BLACK.
TERMINALS BRACKET: PBT,UL94V-0,BLACK.
SHIELD: C2680,T=0.20MM,NICKEL PLATING ON ALL AREA.
TERMINAL: PHOSPHOR BRONZE C5210,T=0.35MM,
30U" GOLD PLATING ON CONTACT AREA.

MECHANICAL:

DURABILITY: 750 CYCLES MIN.
MATING FORCE: 23N MAX.
OPERATING TEMPERATURE: -40°C~+85°C.
STORAGE TEMPERATURE: -40°C~+85°C.
ALL CRITICAL DIMENSIONS WITH "*"

VOOHU 苏州沃虎电子科技有限公司
Su Zhou Voohu Electronic Tech.Co.Ltd

TITLE:
TAB-UP 1X2 10/100BASE

SIZE
A4

UNITS
MM[INCH]

GENERAL TOLERANCES
UNLESS SPECIFIED

APPROVED BY:
Geoffrey.Song

PART NO.:
SYT312B002AC2A4DBMZN

SACLE
1:1

REV
A0

$x \pm 0.35$
 $.x \pm 0.30$

CHECKED BY:
Elvis.Song

TEL: +86 400 1048 018

WEB: WWW.WOHU-TEK.COM

REMARK:

SHEET
1/3



$.xx \pm 0.25$
 $.xxx \pm 0.10$

DESIGND BY:
Sunny.Xu

REACH & RoHS
COMPLIANT

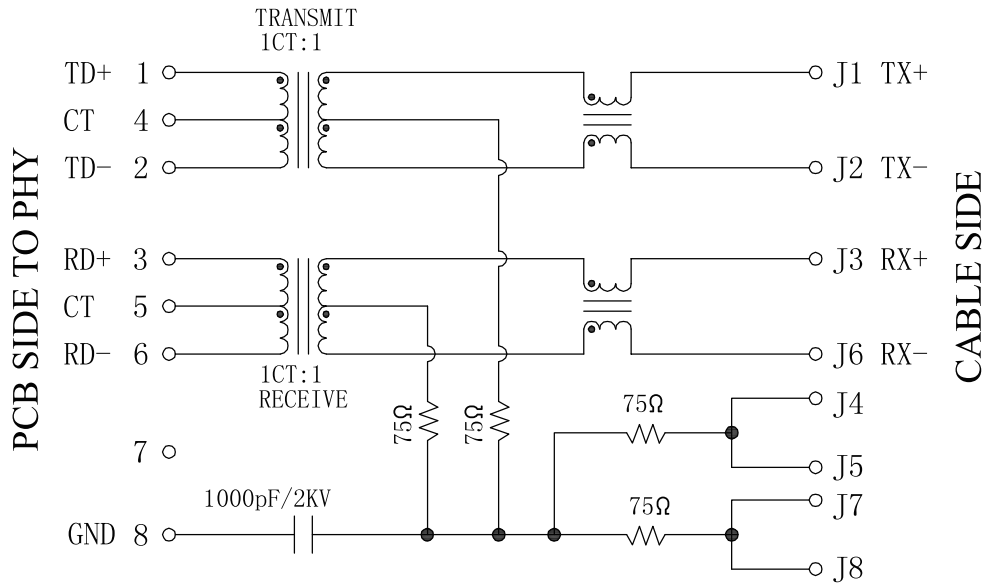

PCB SIDE TO PHY

CABLE SIDE

Electrical:

- Turn ratio: 1~2: J1~J2=1CT:1CT(±2%).
3~6: J3~J6=1CT:1CT(±2%).
- OCL: 350uH Min. at 100KHz 100mV 8mA DC.
- Insertion Loss: -1.0 dB Max 1~100MHz.
- Return loss: -20dB Min 1~10MHz;
-16dB Min 10~30MHz.
-12dB Min 30~60MHz.
-10dB Min 60~80MHz.
- Cross talk: -40dB Min 1~30MHz;
-35dB Min 30~60MHz;
-30dB Min 60~100MHz;
- CMR: -30dB Min 1~100MHz;
- Hi-Pot: 1500V AC & 2250V DC
6S 1mA PRI TO SEC

LED Specification

Standard LED Color	LED Wavelength	Foward(A)	Foward(V)
Green	568nm	20mA	1.85-2.45V
Yellow	585nm	20mA	1.7-2.2V

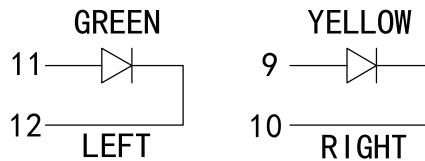

VOOHU 苏州沃虎电子科技有限公司
Su Zhou Voohu Electronic Tech.Co.Ltd

TITLE:
TAB-UP 1X2 10/100BASE

SIZE
A4
UNITS
MM[INCH]

GENERAL TOLERANCES
UNLESS SPECIFIED

APPROVED BY:
Geoffrey.Song

PART NO.:
SYT312B002AC2A4DBMZN

SACLE
1:1
REV
A0

$x \pm 0.35$ $x^\circ \pm 3.0^\circ$
 $.x \pm 0.30$ $.x^\circ \pm 2.0^\circ$

CHECKED BY:
Elvis.Song

TEL: +86 400 1048 018

WEB: WWW.WOHU-TEK.COM

REMARK:

SHEET
2/3

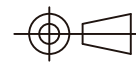

$.xx \pm 0.25$ $.xx^\circ \pm 1.5^\circ$
 $.xxx \pm 0.10$ $.xxx^\circ \pm 1.0^\circ$

DESIGND BY:
Sunny.Xu

REACH & RoHS
COMPLIANT

PROFILE OF WAVE SOLDER

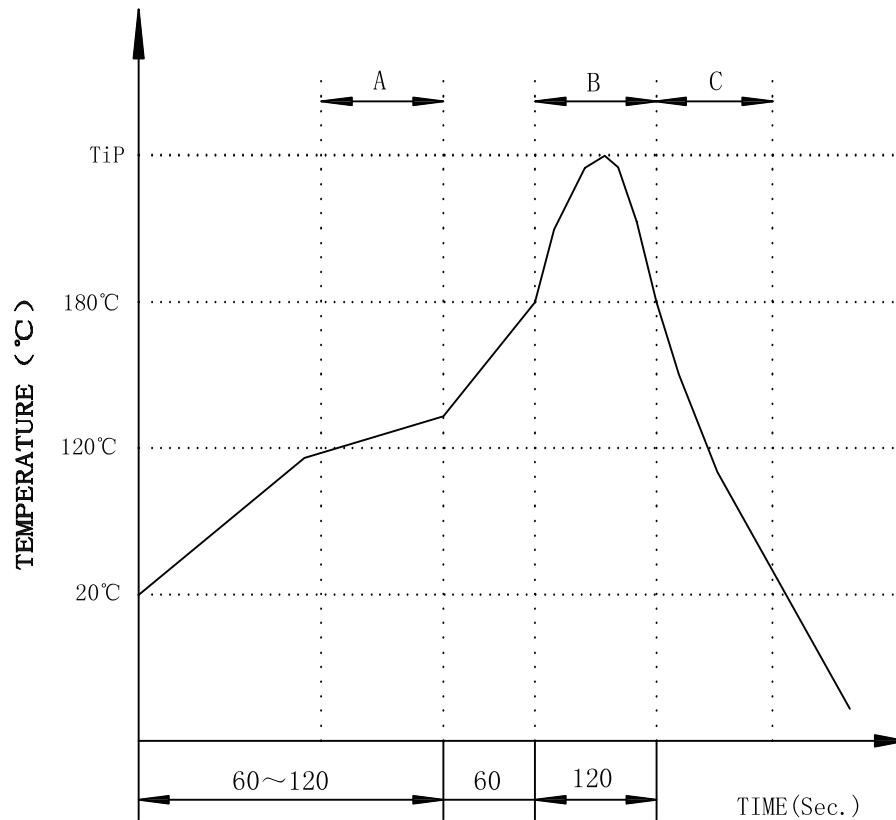

A.Preheating B.Soldering C.Gradual Cooling
 Tip temperature:260±5°C.
 Tip temperature time:5Sec Max.
 Tip melting point of Sn96.5/Ag3/Cu0.5:217°C.

Remarks: after wave soldering, the plastic
 positioning columns of the product which under the
 PCB will be slightly melted, but it won't affect its
 function.

VOOHU 苏州沃虎电子科技有限公司
 Su Zhou Voohu Electronic Tech.Co.Ltd

TITLE:
TAB-UP 1X2 10/100BASE
 PART NO.:
SYT312B002AC2A4DBMZN

SIZE
A4
 UNITS
MM[INCH]
 SACLE
1:1
 REV
A0

GENERAL TOLERANCES
UNLESS SPECIFIED

x±0.35	x°±3.0°
.x±0.30	.x°±2.0°
.xx±0.25	.xx°±1.5°
.xxx±0.10	.xxx°±1.0°

APPROVED BY:
Geoffrey.Song
 CHECKED BY:
Elvis.Song
 DESIGND BY:
Sunny.Xu

TEL: +86 400 1048 018

WEB: WWW.WOHU-TEK.COM

REMARK:

SHEET
3/3



DESIGN TOLERANCES

.xx±0.25	.xx°±1.5°
.xxx±0.10	.xxx°±1.0°