

REACH & RoHS  
COMPLIANT

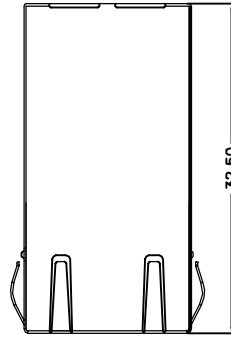

TOP VIEW

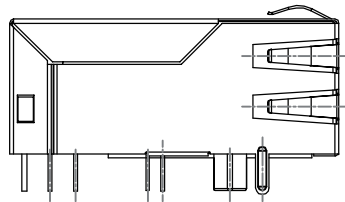

LEFT SIDE VIEW

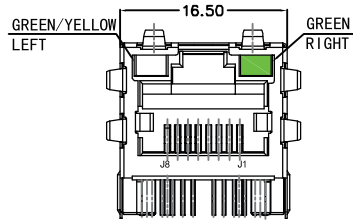

FRONT VIEW

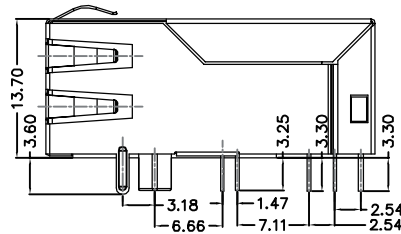

RIGHT SIDE VIEW

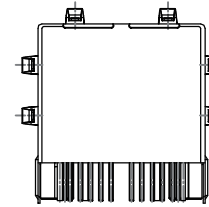

BACK VIEW

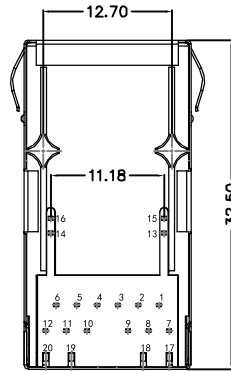

BOTTOM VIEW

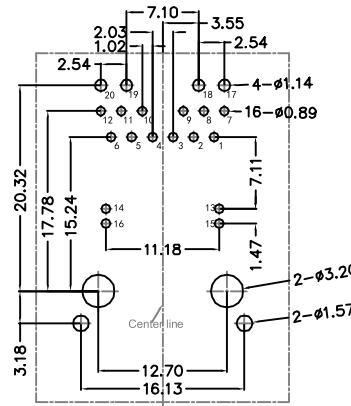

RECOMMENDED PCB LAYOUT  
VIEWED FROM COMPONENT SIDE

**MATERIAL:**

HOUSING: PBT,UL94V-0,BLACK.  
TERMINALS BRACKET: PBT,UL94V-0,BLACK.  
SHIELD: C2680,T=0.20MM,NICKEL PLATING ON ALL AREA.  
TERMINAL: PHOSPHOR BRONZE C5210,T=0.35MM,  
6U" GOLD PLATING ON CONTACT AREA.

**MECHANICAL:**

DURABILITY: 750 CYCLES MIN.  
MATING FORCE: 23N MAX.  
OPERATING TEMPERATURE: -40°C~+85°C.  
STORAGE TEMPERATURE: -40°C~+85°C.  
ALL CRITICAL DIMENSIONS WITH "±"

**VOOHU** 苏州沃虎电子科技有限公司  
Su Zhou Voohu Electronic Tech.Co.Ltd

TITLE:  
TAB-UP 1000BASE POE+

SIZE  
A4

UNITS  
MM[INCH]

GENERAL TOLERANCES  
UNLESS SPECIFIED

APPROVED BY:  
Geoffrey.Song

PART NO.:  
SYT411Q199DJ3A1DP

SACLE  
1:1

REV  
A0

$x \pm 0.35$   $x^\circ \pm 3.0^\circ$   
 $.x \pm 0.30$   $.x^\circ \pm 2.0^\circ$

CHECKED BY:  
Elvis.Song

TEL: +86 400 1048 018

WEB: WWW.WOHU-TEK.COM

REMARK:

SHEET  
1/3



$.xx \pm 0.25$   $.xx^\circ \pm 1.5^\circ$   
 $.xxx \pm 0.10$   $.xxx^\circ \pm 1.0^\circ$

DESIGND BY:  
Sunny.Xu

REACH & RoHS  
COMPLIANT

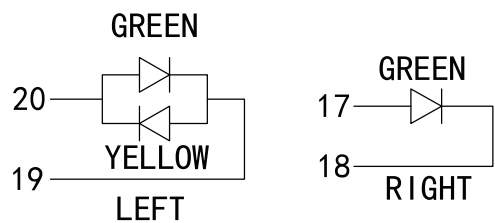
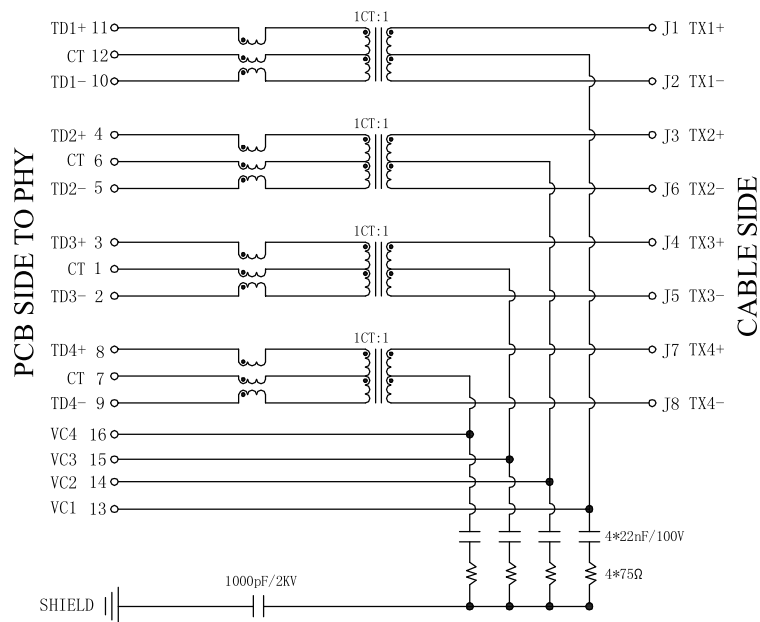

**Electrical:**

- Turn ratio: 1~10: J1~J2=1CT:1CT(±2%),  
4~5: J3~J6=1CT:1CT(±2%),  
3~2: J4~J5=1CT:1CT(±2%),  
8~9: J7~J8=1CT:1CT(±2%).
- OCL: 350uH Min. @ 100KHz 100mV  
RMS(4Channel) 15mA DC BIAS.
- Insertion Loss: -1.0 dB Max 1~100MHz.
- Return loss: -18dB Min 1~30MHz;  
-14dB Min 30~60MHz.  
-12dB Min 60~80MHz.  
-10dB Min 80~100MHz.
- Cross talk: -40dB Min 1~30MHz;  
-35dB Min 30~60MHz;  
-30dB Min 60~100MHz;
- CMR: -30B Min 1~100MHz;
- Hi-Pot: 2250V DC 6S 1mA PRI TO SEC
- Single port magnetic jack POE magnetics acc.  
To IEEE802.3bt for PSE or PD applications.
- 100% of production tested to comply with  
IEEE 802.3 isolation requirements balanced DC  
line current 720mA max. 57V DC continuous.

**LED Specification**

Standard LED Color	LED Wavelength	Foward(A)	Foward(V)
Green	568nm	20mA	1.85-2.45V
Yellow	585nm	20mA	1.7-2.2V

**VOOHU** 苏州沃虎电子科技有限公司  
Su Zhou Voohu Electronic Tech.Co.Ltd

TITLE:  
TAB-UP 1000BASE POE+

SIZE  
A4

UNITS  
MM[INCH]

GENERAL TOLERANCES  
UNLESS SPECIFIED

PART NO.:  
SYT411Q199DJ3A1DP

SACLE  
1:1

REV  
A0

x±0.35 x°±3.0°  
.x±0.30 .x°±2.0°

APPROVED BY:  
Geoffrey.Song  
CHECKED BY:  
Elvis.Song

TEL: +86 400 1048 018

WEB: WWW.WOHU-TEK.COM

REMARK:

SHEET  
2/3

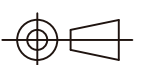

.xx±0.25 .xx°±1.5°  
.xxx±0.10 .xxx°±1.0°

DESIGND BY:  
Sunny.Xu

REACH & RoHS  
COMPLIANT

# PROFILE OF WAVE SOLDER

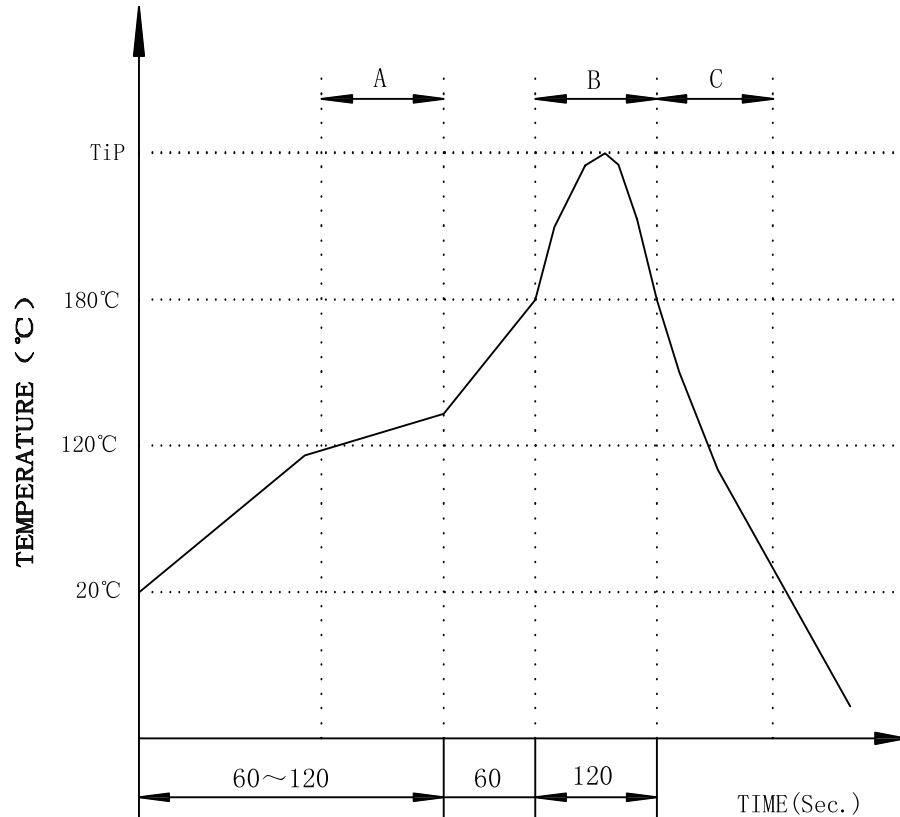

A.Preheating B.Soldering C.Gradual Cooling  
 Tip temperature:260±5°C.  
 Tip temperature time:5Sec Max.  
 Tip melting point of Sn96.5/Ag3/Cu0.5:217°C.

Remarks: after wave soldering, the plastic positioning columns  
 of the product which under the PCB will be slightly melted,  
 but it won't affect its function.

**VOOHU** 苏州沃虎电子科技有限公司  
 Su Zhou Voohu Electronic Tech.Co.Ltd

TITLE:  
TAB-UP 1000BASE POE+

SIZE  
A4  
UNITS  
MM[INCH]

GENERAL TOLERANCES  
UNLESS SPECIFIED

APPROVED BY:  
Geoffrey.Song

PART NO.:  
SYT411Q199DJ3A1DP

SACLE  
1:1

REV  
A0

x±0.35	x°±3.0°
.x±0.30	.x°±2.0°

CHECKED BY:  
Elvis.Song

TEL: +86 400 1048 018

WEB: [WWW.WOHU-TEK.COM](http://WWW.WOHU-TEK.COM)

REMARK:

SHEET  
3/3



.xx±0.25	.xx°±1.5°
.xxx±0.10	.xxx°±1.0°

DESIGND BY:  
Sunny.Xu