

REACH & RoHS  
COMPLIANT

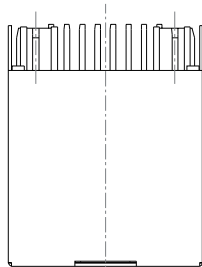

TOP VIEW

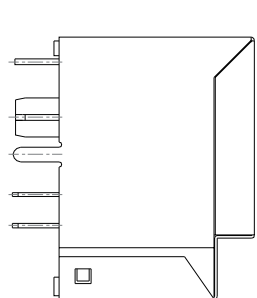

LEFT SIDE VIEW

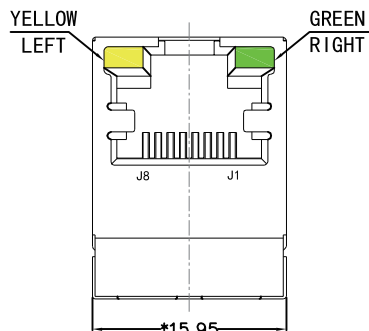

FRONT VIEW

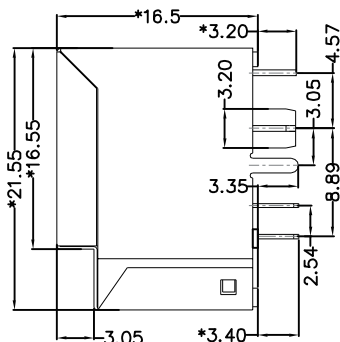

RIGHT SIDE VIEW

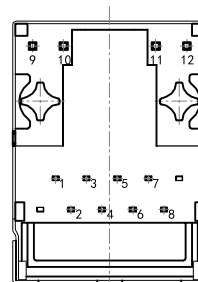

BACK VIEW

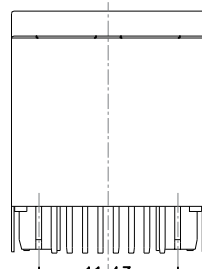

BOTTOM VIEW

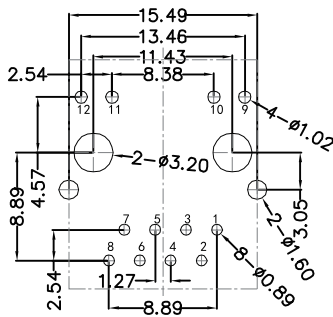

RECOMMENDED PCB LAYOUT  
VIEWED FROM COMPONENT SIDE

**MATERIAL:**

HOUSING: PBT,UL94V-0,BLACK.  
TERMINALS BRACKET: PBT,UL94V-0,BLACK.  
SHIELD: C2680,T=0.20MM,NICKEL PLATING ON ALL AREA.  
TERMINAL: PHOSPHOR BRONZE C5210,T=0.35MM,  
6U" GOLD PLATING ON CONTACT AREA.

**MECHANICAL:**

DURABILITY: 750 CYCLES MIN.  
MATING FORCE: 23N MAX.  
OPERATING TEMPERATURE: -40°C~+85°C.  
STORAGE TEMPERATURE: -40°C~+85°C.  
ALL CRITICAL DIMENSIONS WITH "\*"

**VOOHU** 苏州沃虎电子科技有限公司  
Su Zhou Voohu Electronic Tech.Co.Ltd

TITLE:  
TAB-UP 1×1 100BASE

PART NO.:  
SYT511B002AA1A1D068-带缺口

REMARK:

SIZE  
A4  
UNITS  
MM[INCH]

SACLE  
1:1  
REV  
A0

SHEET  
1/3



GENERAL TOLERANCES  
UNLESS SPECIFIED

x±0.35	x°±3.0°
.x±0.30	.x°±2.0°
.xx±0.25	.xx°±1.5°
.xxx±0.10	.xxx°±1.0°

APPROVED BY:  
Geoffrey.Song

CHECKED BY:  
Elvis.Song

DESIGND BY:  
Sunny.Xu

TEL: +86 400 1048 018

WEB: WWW.WOHU-TEK.COM

REACH & RoHS  
COMPLIANT

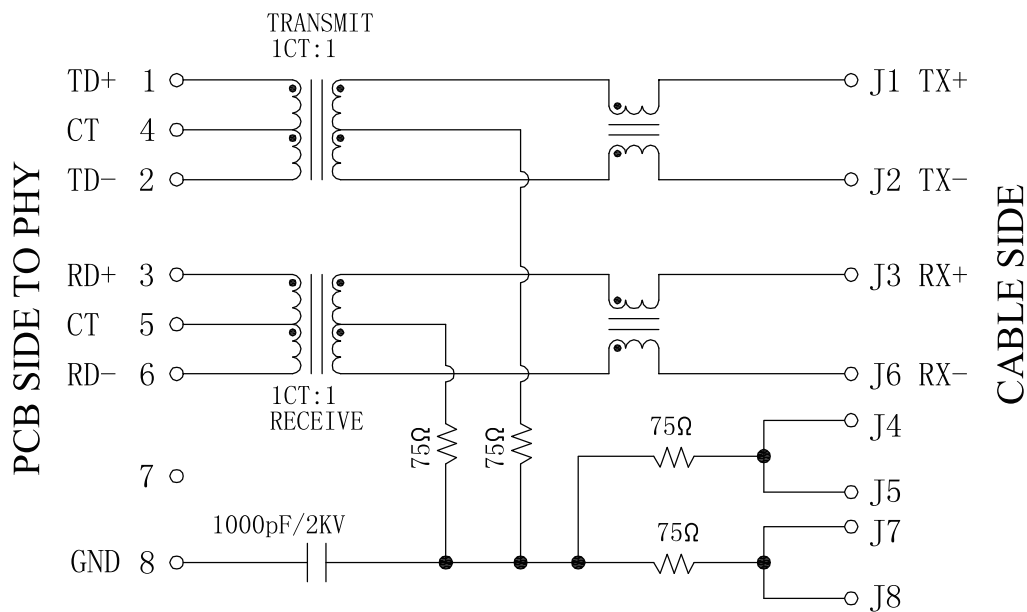

**Electrical:**

1. Turn ratio: 1~2: J1~J2 = 1CT:1CT(±2%).  
3~6: J3~J6 = 1CT:1CT(±2%).
2. OCL: 350uH Min. at 100KHz 100mV 8mA DC.
3. Insertion Loss: -1.0 dB Max 1~100MHz.
4. Return loss: -20dB Min 1~10MHz;  
-1 6dB Min 10~30MHz;  
-1 2dB Min 30~60MHz;  
-10dB Min 60~80MHz.
5. Cross talk: -40dB Min 1~30MHz;  
-35dB Min 30~60MHz;  
-30dB Min 60~100MHz;
6. CMR: -35dB Min 1~100MHz;
7. Hi-Pot: 1500V AC & 2250V DC  
6S 1mA PRI TO SEC

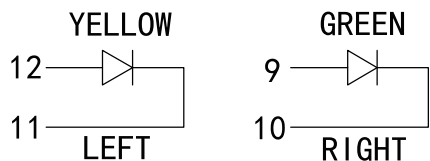

**LED Specification**

Standard LED Color	LED Wavelength	Foward(A)	Foward(V)
Green	568nm	20mA	1.85-2.45V
Yellow	585nm	20mA	1.7-2.2V

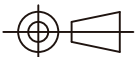
 <b>苏州沃虎电子科技有限公司</b> Su Zhou Voohu Electronic Tech.Co.Ltd	TITLE: TAB-UP 1×1 100BASE	SIZE A4	UNITS MM[INCH]	GENERAL TOLERANCES UNLESS SPECIFIED		APPROVED BY: Geoffrey.Song	
	PART NO.: SYT511B002AA1A1D068-带缺口	SACLE 1:1	REV A0	x±0.35	x°±3.0°	CHECKED BY: Elvis.Song	
TEL: +86 400 1048 018	WEB: WWW.WOHU-TEK.COM	REMARK:	SHEET 2/3		.xx±0.25 .xxx±0.10	x°±1.5° .xxx°±1.0°	DESIGND BY: Sunny.Xu

REACH & RoHS  
COMPLIANT

# PROFILE OF WAVE SOLDER

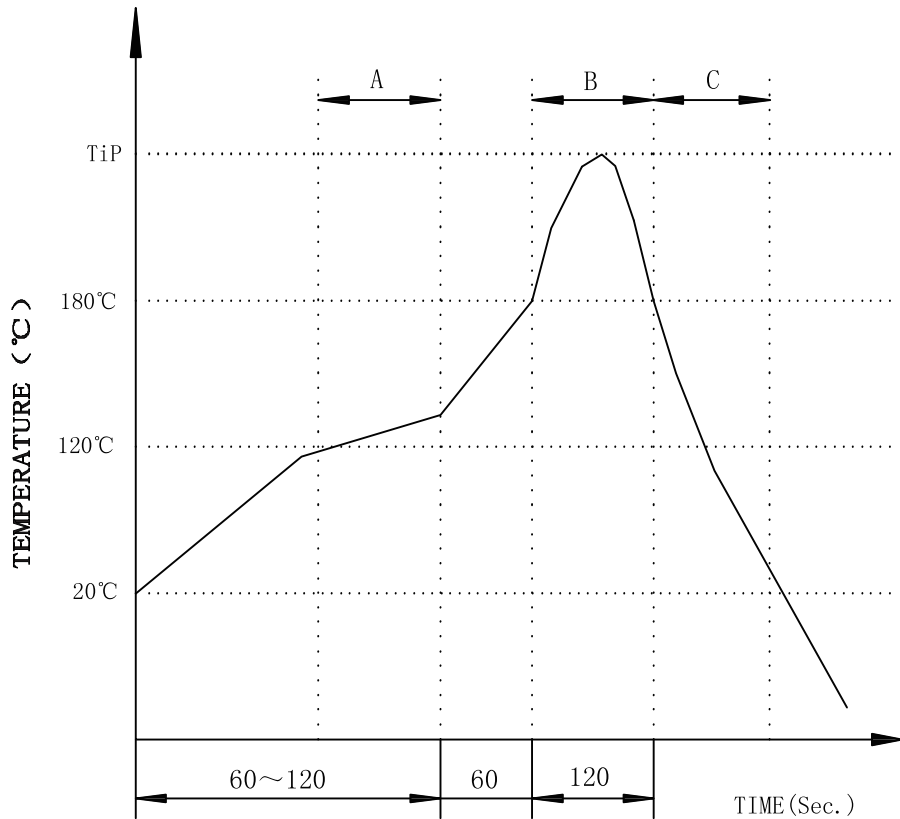

A.Preheating B.Soldering C.Gradual Cooling  
 Tip temperature:260±5°C.  
 Tip temperature time:5Sec Max.  
 Tip melting point of Sn96.5/Ag3/Cu0.5:217°C.

Remarks: after wave soldering, the plastic positioning columns of the product which under the PCB will be slightly melted, but it won't affect its function.

**VOOHU** 苏州沃虎电子科技有限公司  
 Su Zhou Voohu Electronic Tech.Co.Ltd

TITLE:  
 TAB-UP 1×1 100BASE

SIZE  
 A4  
 UNITS  
 MM[INCH]

GENERAL TOLERANCES  
 UNLESS SPECIFIED

APPROVED BY:  
 Geoffrey.Song

PART NO.:  
 SYT511B002AA1A1D068-帶缺口

SACLE  
 1:1  
 REV  
 A0

x±0.35	x°±3.0°
.x±0.30	.x°±2.0°

CHECKED BY:  
 Elvis.Song

TEL: +86 400 1048 018

WEB: [WWW.WOHU-TEK.COM](http://WWW.WOHU-TEK.COM)

REMARK:

SHEET  
 3/3



.xx±0.25	.xx°±1.5°
.xxx±0.10	.xxx°±1.0°

DESIGND BY:  
 Sunny.Xu