

REACH & RoHS COMPLIANT

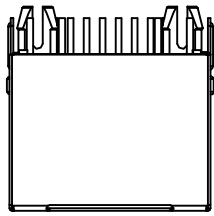

TOP VIEW

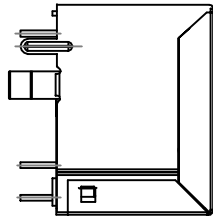

LEFT SIDE VIEW

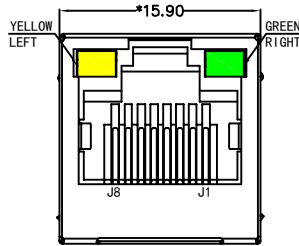

FRONT VIEW

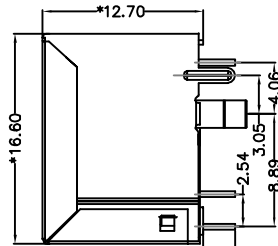

RIGHT SIDE VIEW

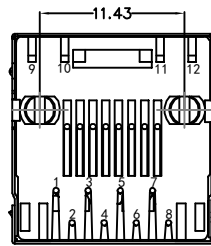

BACK VIEW

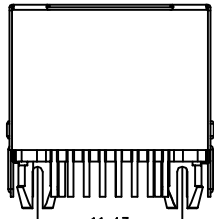

BOTTOM VIEW

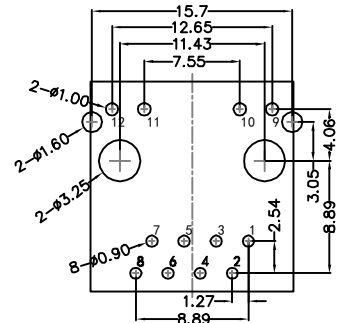

RECOMMENDED PCB LAYOUT VIEWED FROM COMPONENT SIDE

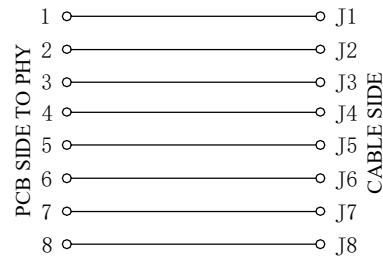

**MATERIAL:**

HOUSING: LCP,UL94V-0,BLACK.  
 TERMINAL: PHOSPHOR BRONZE T=0.46MM,  
 0.6U" GOLD PLATING ON CONTACT AREA.  
 SHIELD: C2680,T=0.20MM,20 MIN NICKEL PLATING  
 ON ALL AREA.

**MACHANICAL:**

DURABILITY: 750 CYCLES MIN,12.5MM/MINUTE.  
 INSERTION FORCE : 2.2KG.F MAX.  
 RETENTION STRENGTH : 7.7KG.F BETWEEN JACK AND PLUG .  
 OPERATING TEMPERATURE: -40 °C~+85 °C.  
 STORAGE TEMPERATURE: -40°C~+85°C.  
 ALL CRITICAL DIMENSIONS WITH "\*"

**ELECTRICAL:**

VOLTAGE: 125 VOLTS AC.  
 CURRENT RATING : 1.5AMP.  
 DIELECTRIC STRENGTH : 1000 VAC RMS 50HZ OR 60HZ,1 MIN.  
 INSULATION RESISTANCE: 500 MEGA OHMS MIN. INITIAL  
 AFTER 500V DC FOR 1 MINUTE.  
 CONTACT RESISTANCE: SINGLE TERMINAL 30 MILLIOHMS MAX.  
 INITIAL 50 MILLIOHMS MAX. AFTER  
 DURABILITY TEST.

**LED Specification**

Standard LED Color	LED Wavelength	Foward(A)	Foward(V)
Green	568nm	20mA	1.8-2.8V
Yellow	585nm	20mA	1.8-2.8V

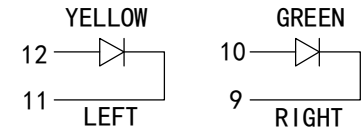

**VOOHU** 苏州沃虎电子科技有限公司  
 Su Zhou Voohu Electronic Tech.Co.Ltd

TITLE:  
180° TAB-UP

SIZE  
A4  
MM[INCH]

GENERAL TOLERANCES  
UNLESS SPECIFIED

APPROVED BY:  
Geoffrey.Song

PART NO.:  
SYT52A1188AB1A6D1Y1143

SACLE  
1:1  
REV  
A0

$x \pm 0.35$      $x^\circ \pm 3.0^\circ$   
 $.x \pm 0.30$      $.x^\circ \pm 2.0^\circ$

CHECKED BY:  
Elvis.Song

REMARK:

SHEET  
1/1

$.xx \pm 0.25$      $.xx^\circ \pm 1.5^\circ$   
 $.xxx \pm 0.10$      $.xxx^\circ \pm 1.0^\circ$

DESIGND BY:  
Sunny.Xu

TEL: +86 400 1048 018

WEB: WWW.WOHU-TEK.COM