

REACH & RoHS
COMPLIANT

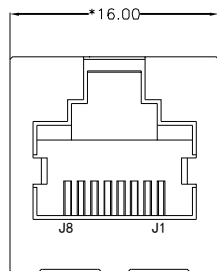

FRONT VIEW

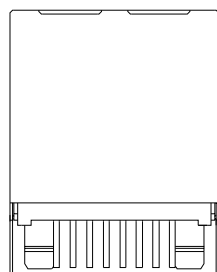

BOTTOM VIEW

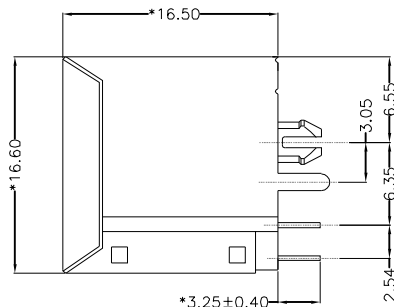

RIGHT SIDE VIEW

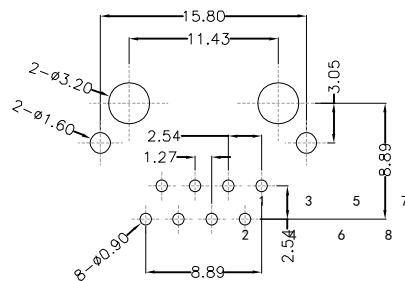

RECOMMENDED PCB LAYOUT
VIEWED FROM COMPONENT SIDE

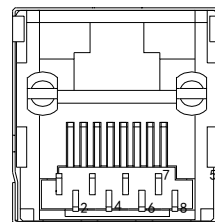

BACK VIEW

MATERIAL:

HOUSING: PBT,UL94V-0,BLACK.
TERMINAL: PHOSPHOR BRONZE T=0.35MM,
6U" GOLD PLATING ON CONTACT AREA.
SHIELD: C2680,T=0.20MM,20 MIN NICKEL PLATING
ON ALL AREA.

MACHANICAL:

DURABILITY: 750 CYCLES MIN,12.5MM/MINUTE.
INSERTION FORCE: 2.2KG.F MAX.
RETENTION STRENGTH : 7.7KG.F BETWEEN JACK AND PLUG.
OPERATING TEMPERATURE: -40°C~+85°C.
STORAGE TEMPERATURE: -40°C~+85°C.
3 ALL CRITICAL DIMENSIONS WITH "*"

ELECTRICAL:

VOLTAGE: 125 VOLTS AC.
CURRENT RATING : 1.5AMP.
DIELECTRIC STRENGTH: 1000 VAC RMS 50HZ OR 60HZ,1MIN.
INSULATION RESISTANCE: 500 MEGA OHMS MIN. INITIAL
AFTER 500V DC FOR 1 MINUTE.
CONTACT RESISTANCE: SINGLE TERMINAL 30 MILLIOHMS MAX.
INITIAL 50 MILLIOHMS MAX. AFTER
DURABILITY TEST.

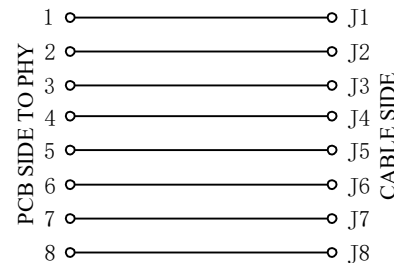

VOOHU 苏州沃虎电子科技有限公司
Su Zhou Voohu Electronic Tech.Co.Ltd

TEL: +86 400 1048 018

WEB: WWW.WOHU-TEK.COM

TITLE:
180° TAB-UP

PART NO.:
SYT52241188GWA1D8B4

REMARK:

SIZE
A4

SACLE
1:1

SHEET
1/1

UNITS
MM[INCH]

REV
A0

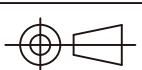

GENERAL TOLERANCES
UNLESS SPECIFIED

x±0.35	x°±3.0°
.x±0.30	.x°±2.0°
.xx±0.25	.xx°±1.5°
.xxx±0.10	.xxx°±1.0°

APPROVED BY:
Geoffrey.Song

CHECKED BY:
Elvis.Song

DESIGND BY:
Sunny.Xu