

REACH & RoHS  
COMPLIANT

REV.	ECN / DESCRIPTION	BY	DATE
A0	NEW	ZG.HU	2018.05.21
A1	MODIFY OPERATING TEMPERATURE	ZG.HU	2020.04.20

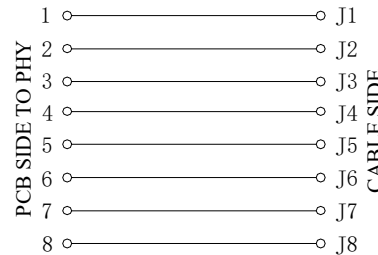
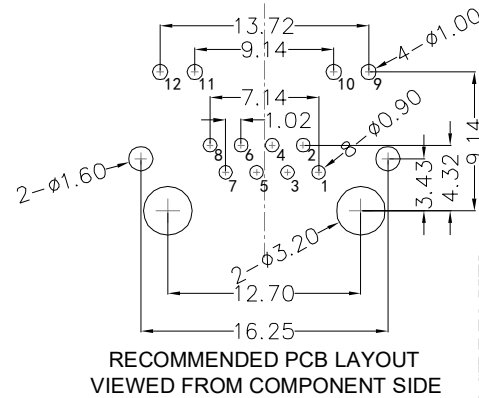
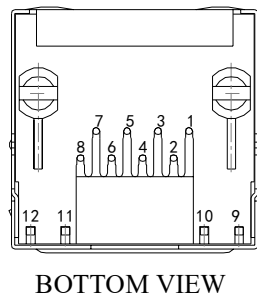
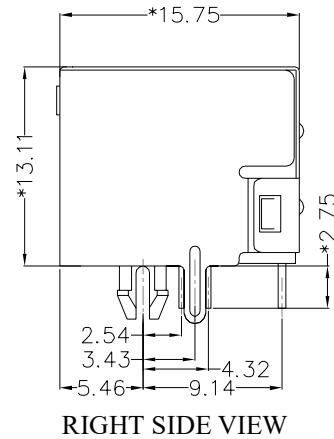
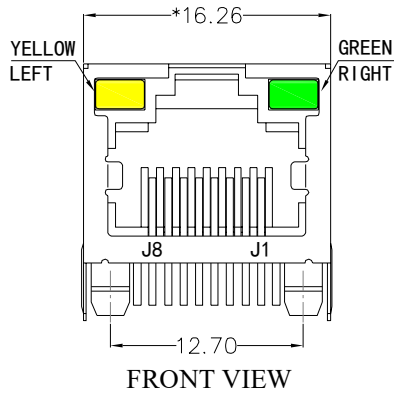

**MATERIAL:**

HOUSING: PBT,UL94V-0,BLACK.  
TERMINAL: PHOSPHOR BRONZE Ø=0.46MM, G/FU" GOLD PLATING.  
SHIELD: C2680,T=0.20MM,20U" MIN NICKEL PLATING  
ON ALL AREA.

**MACHANICAL:**

DURABILITY: 750 CYCLES MIN,12.5MM/MINUTE.  
INSERTION FORCE: 2.2KG.F MAX.  
RETENTION STRENGTH : 7.7KG.F BETWEEN JACK AND PLUG.  
OPERATING TEMPERATURE: -40℃~+105℃.  
STORAGE TEMPERATURE: -40℃~+85℃.  
ALL CRITICAL DIMENSIONS WITH "\*\*"

**ELECTRICAL:**

VOLTAGE: 125 VOLTS AC.  
CURRENT RATING: 1.5AMP.  
DIELECTRIC STRENGTH: 1000 VAC RMS 50HZ OR 60HZ,1MIN.  
INSULATION RESISTANCE: 500 MEGA OHMS MIN. INITIAL  
AFTER 500V DC FOR 1 MINUTE.  
CONTACT RESISTANCE: SINGLE TERMINAL 30 MILLIOHMS MAX.  
INITIAL 50 MILLIOHMS MAX. AFTER  
DURABILITY TEST.

**LED Specification**

Standard LED Color	LED Wavelength	Foward(A)	Foward(V)
Green	568nm	20mA	1.85-2.45V
Yellow	585nm	20mA	1.7-2.2V

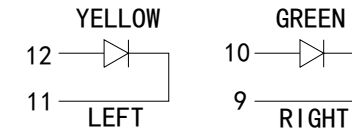

**VOOHU** 苏州沃虎电子科技有限公司  
Su Zhou Voohu Electronic Tech.Co.Ltd

TITLE:  
RJ45直通 56带屏蔽带灯

SIZE  
A4

UNITS  
MM[INCH]

GENERAL TOLERANCES  
UNLESS SPECIFIED

APPROVED BY:  
Geoffrey.Song

PART NO.:  
SYT561188AB1A1DY1006-A1

SACLE  
1:1

REV  
A0

$x \pm 0.35$   
 $.x \pm 0.30$

CHECKED BY:  
Elvis.Song

TEL: +86 400 1048 018

WEB: WWW.WOHU-TEK.COM

REMARK:

SHEET  
1/1

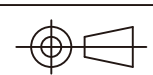

$.xx \pm 0.25$   
 $.xxx \pm 0.10$

DESIGND BY:  
Sunny.Xu