

REACH & RoHS
COMPLIANT

REV.	ECN / DESCRIPTION	BY	DATE
A0	NEW	ZG.HU	2018.06.01
A1	Splice type changed to splice+ one - body assembly product	ZG.HU	2023.03.07

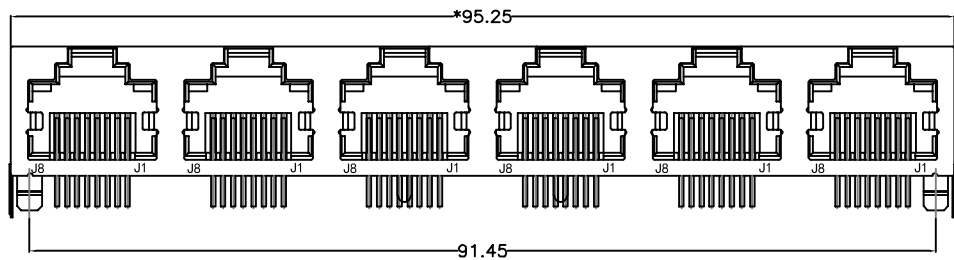

FRONT VIEW

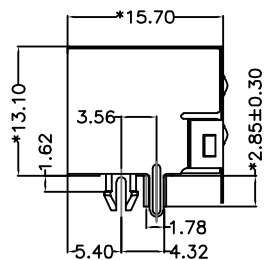

RIGHT SIDE VIEW

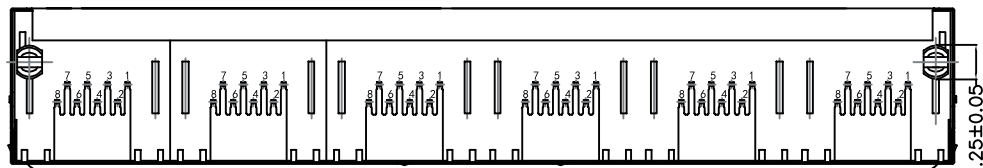

BOTTOM VIEW

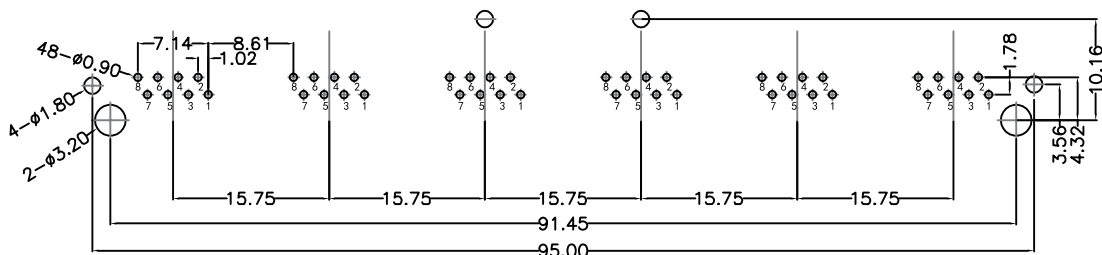

RECOMMENDED PCB LAYOUT
VIEWED FROM COMPONENT SIDE

MATERIAL:

HOUSING: PBT,UL94V-0,BLACK.
TERMINAL: PHOSPHOR BRONZE $\varnothing=0.46\text{MM}$,
G/FU" GOLD PLATING ON CONTACT AREA.
SHIELD: C2680,T=0.20MM,20 MIN NICKEL PLATING
ON ALL AREA.

MACHANICAL:

DURABILITY: 750 CYCLES MIN,12.5MM/MINUTE.
INSERTION FORCE: 2.2KG.F MAX.
RETENTION STRENGTH : 7.7KG.F BETWEEN JACK AND PLUG.
OPERATING TEMPERATURE: -40°C~+85°C.
STORAGE TEMPERATURE: -40°C~+85°C.
ALL CRITICAL DIMENSIONS WITH "*"

ELECTRICAL:

VOLTAGE: 125 VOLTS AC.
CURRENT RATING : 1.5AMP.
DIELECTRIC STRENGTH: 1000 VAC RMS 50HZ OR 60HZ,1MIN.
INSULATION RESISTANCE: 500 MEGA OHMS MIN. INITIAL
AFTER 500V DC FOR 1 MINUTE.
CONTACT RESISTANCE: SINGLE TERMINAL 30 MILLIOHMS MAX.
INITIAL 50 MILLIOHMS MAX. AFTER
DURABILITY TEST.

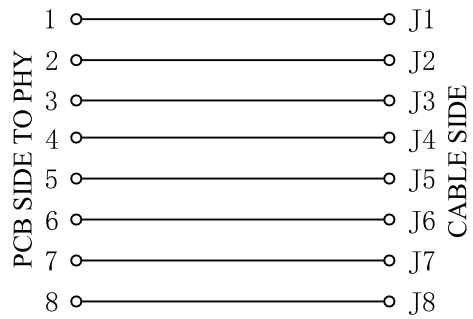

VOOHU 苏州沃虎电子科技有限公司
Su Zhou Voohu Electronic Tech.Co.Ltd

TITLE:
RJ45 1*2 56带屏蔽带灯

PART NO.:
SYT561688GWA1D9Y1022

SIZE
A4

UNITS
MM[INCH]

SACLE
1:1

REV
A0

GENERAL TOLERANCES UNLESS SPECIFIED	
$x\pm 0.35$	$x^\circ\pm 3.0^\circ$
$.x\pm 0.30$	$.x^\circ\pm 2.0^\circ$
$.xx\pm 0.25$	$.xx^\circ\pm 1.5^\circ$
$.xxx\pm 0.10$	$.xxx^\circ\pm 1.0^\circ$

APPROVED BY:
Geoffrey.Song

CHECKED BY:
Elvis.Song

DESIGND BY:
Sunny.Xu

TEL: +86 400 1048 018

WEB: WWW.WOHU-TEK.COM

REMARK:

SHEET
1/2

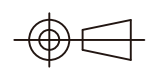

REACH & RoHS
COMPLIANT

REV.	ECN / DESCRIPTION	BY	DATE
A0	NEW	ZG.HU	2018.06.01
A1	Splice type changed to splice+ one - body assembly product	ZG.HU	2023.03.07

Suggested Panel Opening:

Keep-Out Area (Component Side View):

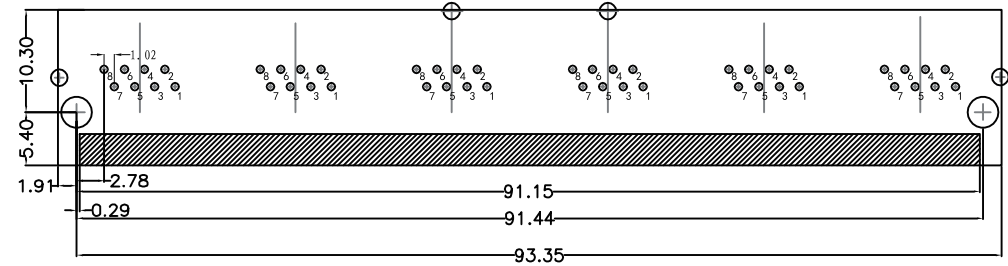
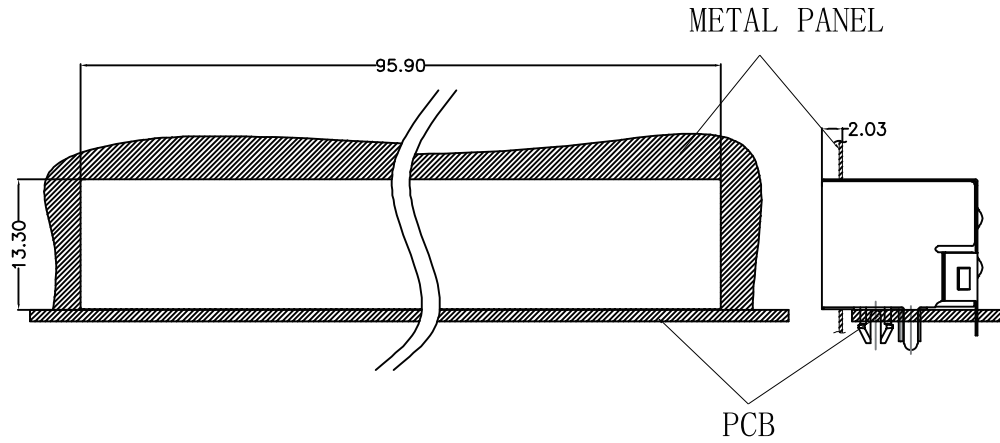

UNIT: mm / inch
Tolerances: $\pm 0.10 / 0.004$

UNIT: mm / inch
Tolerances: $\pm 0.10 / 0.004$

Plug In Side

VOOHU 苏州沃虎电子科技有限公司
Su Zhou Voohu Electronic Tech.Co.Ltd

TITLE:
RJ45 1*2 56带屏蔽带灯
PART NO.:
SYT561688GWA1D9Y1022

SIZE
A4
UNITS
MM[INCH]
SACLE
1:1
REV
A0

GENERAL TOLERANCES
UNLESS SPECIFIED
x ± 0.35 x $^{\circ} \pm 3.0^{\circ}$
.x ± 0.30 .x $^{\circ} \pm 2.0^{\circ}$
.xx ± 0.25 .xx $^{\circ} \pm 1.5^{\circ}$
.xxx ± 0.10 .xxx $^{\circ} \pm 1.0^{\circ}$

APPROVED BY:
Geoffrey.Song
CHECKED BY:
Elvis.Song
DESIGND BY:
Sunny.Xu

TEL: +86 400 1048 018

WEB: WWW.WOHU-TEK.COM

REMARK:

SHEET
2/2

