

REACH & RoHS
COMPLIANT

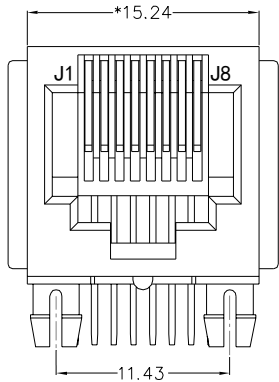

FRONT VIEW

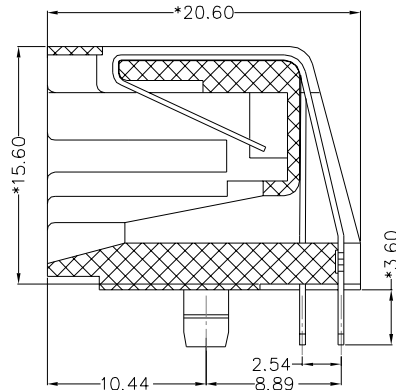

CUTAWAY VIEW

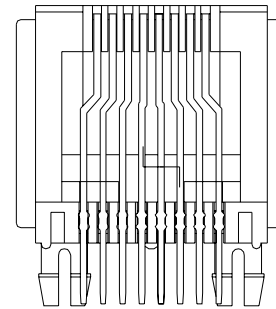

BACK VIEW

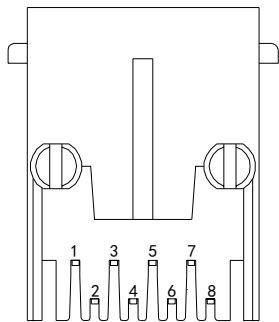

BOTTOM VIEW

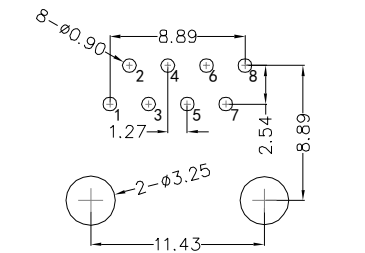

RECOMMENDED PCB LAYOUT
VIEWED FROM COMPONENT SIDE

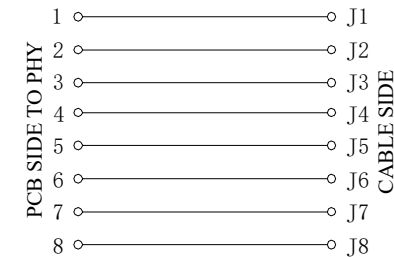
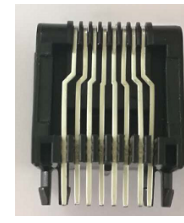
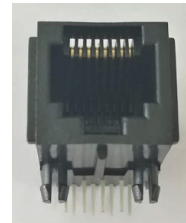

MATERIAL:

HOUSING: PBT,UL94V-0,BLACK.
TERMINAL: PHOSPHOR BRONZE T=0.35MM,
G/FU" GOLD PLATING ON CONTACT AREA.

MACHANICAL:

DURABILITY: 750 CYCLES MIN,12.5MM/MINUTE.
INSERTION FORCE: 2.2KG.F MAX.
RETENTION STRENGTH : 7.7KG.F BETWEEN JACK AND PLUG.
OPERATING TEMPERATURE: -40°C~+85°C.
STORAGE TEMPERATURE: -40°C~+85°C.
ALL CRITICAL DIMENSIONS WITH ""*

ELECTRICAL:

VOLTAGE: 125 VOLTS AC.
CURRENT RATING : 1.5AMP.
DIELECTRIC STRENGTH: 1000 VAC RMS 50HZ OR 60HZ,1MIN.
INSULATION RESISTANCE: 500 MEGA OHMS MIN. INITIAL
AFTER 500V DC FOR 1 MINUTE.
CONTACT RESISTANCE: SINGLE TERMINAL 30 MILLIOHMS MAX.
INITIAL 50 MILLIOHMS MAX. AFTER
DURABILITY TEST.

VOOHU 苏州沃虎电子科技有限公司
Su Zhou Voohu Electronic Tech.Co.Ltd

TEL: +86 400 1048 018

WEB: WWW.WOHU-TEK.COM

TITLE:
RJ45 1*1 8P8C无灯带耳朵

PART NO.:
SYT5721E1188IWA1DB1006

REMARK:

SIZE
A4

SACLE
1:1

SHEET
1/1

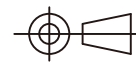

UNITS
MM[INCH]

GENERAL TOLERANCES
UNLESS SPECIFIED

| | |
|-----------|------------|
| x±0.35 | x°±3.0° |
| .x±0.30 | .x°±2.0° |
| .xx±0.25 | .xx°±1.5° |
| .xxx±0.10 | .xxx°±1.0° |

APPROVED BY:
Geoffrey.Song

CHECKED BY:
Elvis.Song

DESIGND BY:
Sunny.Xu