

CUSTOMER DRAWING

NOTE:
MATERIAL:

1. CONTACT: PHOSPHOR BRONZE.
2. CONNECTOR HOUSING: LCP UL 94V-0. COLOR: BLACK.
3. MOULDED INSERT: HIGH TEMPERATURE PLASTIC UL 94V-0. COLOR:BLACK.
4. CAGE: COPPER ALLOY.
5. LIGHT PIPES: POLYCARBONATE. UL 94V-0. COLOR:CLEAR
6. LIGHT PIPE HOUSING: PBT UL 94V-0 COLOR:BLACK.

PLATED:

1. CONTACT MATING AREA : PLATING GOLD OVER 1.27 MICROMETERS MINIMUM NICKEL.
2. CONTACT NEEDLE EYE: 1.27 MICROMETERS MINIMUM MATTE TIN OVER 1.27 MICROMETERS MINIMUM NICKEL.

MECHANICAL REQUIREMENT:

1. DURABILITY: 100 CYCLES MIN.
2. INSERTION AND EXTRACTION FORCE: 40N MAX & 11.5N MAX

ENVIRONMENTAL:

1. LOW LEVEL CONTACT RESISTANCE(LLCR):
ΔR 20 MILLIOHMS MAXIMUM FOR SHIELD AND SIGNAL CONTACTS.
2. DIELECTRIC WITHSTANDING VOLTAGE: 300V AC/MAX.
3. INSULATION RESISTANCE: 1×10^9 OHMS MINIMUM.
4. RATINGS CURRENT: 0.5 AMPS MAX.
5. RATINGS VOLTAGE: 30 VOLTS DC/AC(RMS) MAX.
6. OPERATION: $-40^{\circ}\text{C} \sim +85^{\circ}\text{C}$.
7. STORAGE: $-55^{\circ}\text{C} \sim +105^{\circ}\text{C}$.
8. ROHS COMPLIANT

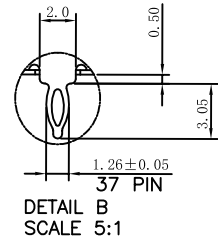
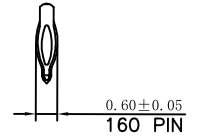
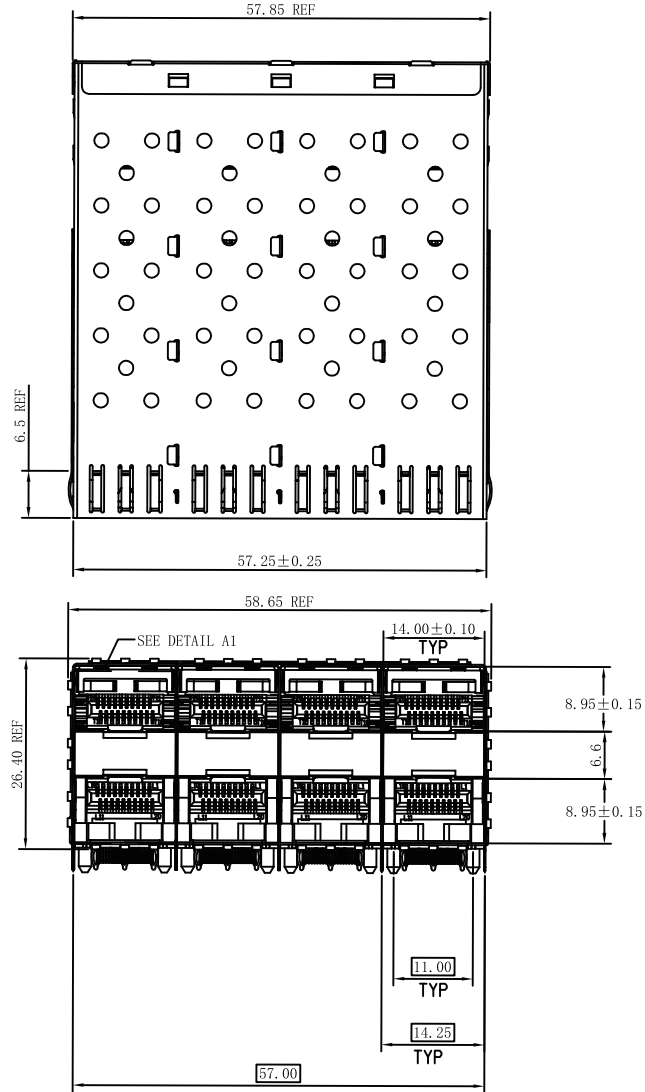
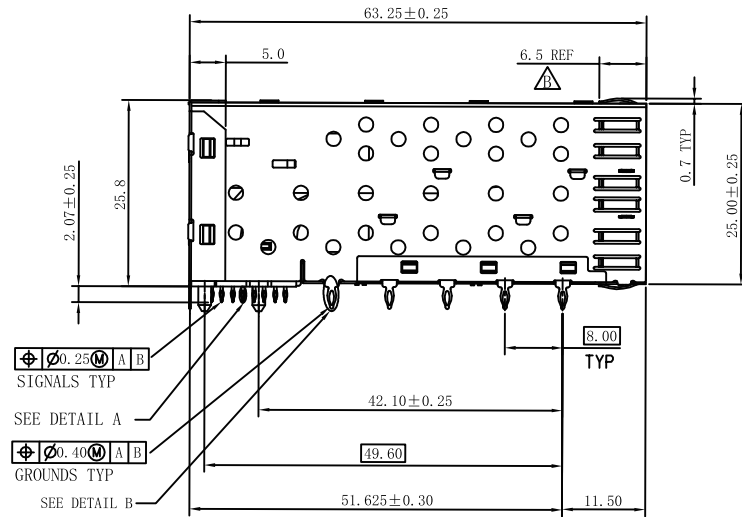

RoHS Compliant

VOOHU 苏州沃虎电子科技有限公司
Su Zhou Voohu Electronic Tech.Co.Ltd

TITLE:
SFP 2X4 CONNECTOR

SIZE
A4

UNITS
MM[INCH]

GENERAL TOLERANCES
UNLESS SPECIFIED

PART NO.:
WHSFP0524D003

SACLE
1:1

REV
A0

$x \pm 0.35$ $x^{\circ} \pm 3.0^{\circ}$
 $.x \pm 0.30$ $.x^{\circ} \pm 2.0^{\circ}$

APPROVED BY:
Geoffrey.Song
CHECKED BY:
Elvis.Song

REMARK:
gold plated 15u"

SHEET
1/4

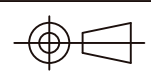

$.xx \pm 0.25$ $.xx^{\circ} \pm 1.5^{\circ}$
 $.xxx \pm 0.10$ $.xxx^{\circ} \pm 1.0^{\circ}$

DESIGND BY:
Sunny.Xu

TEL: +86 400 1048 018

WEB: WWW.WOHU-TEK.COM

CUSTOMER DRAWING

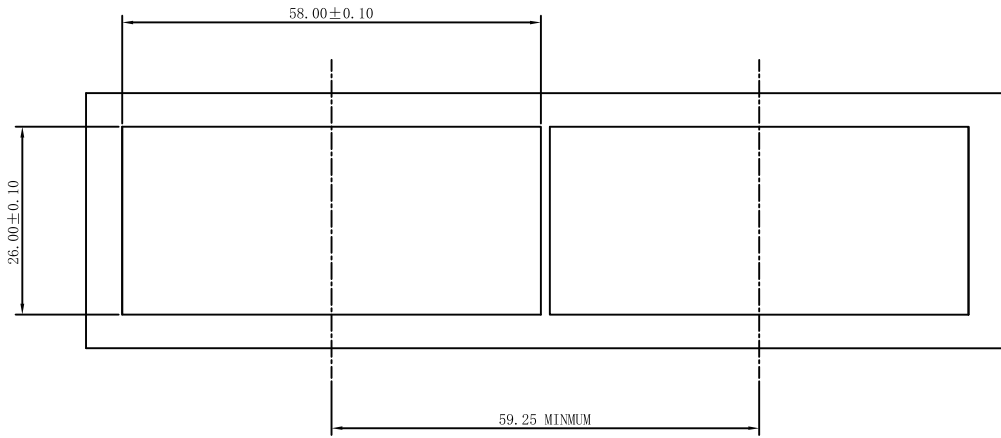

BEZEL CUT-OUT CENTER SPACING DETAIL
BEZEL THICKNESS: 0.8-2.6

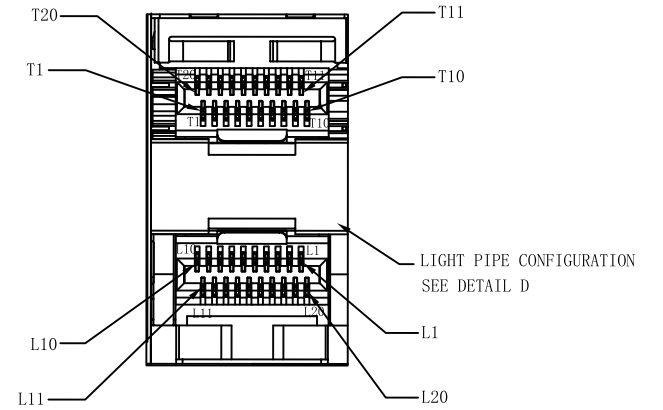
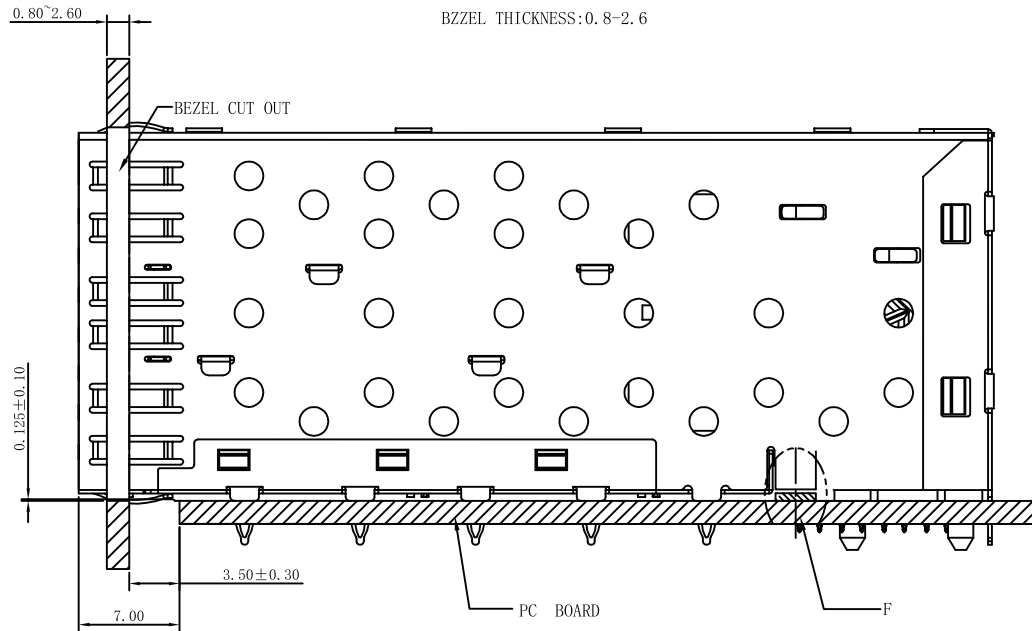

DETAIL A1
SCALE 4:1

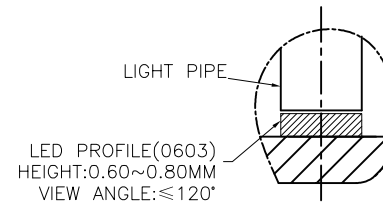

DETAIL F
SCALE 4:1

RoHS Compliant

VOOHU 苏州沃虎电子科技有限公司
Su Zhou Voohu Electronic Tech.Co.Ltd

TITLE:
SFP 2X4 CONNECTOR

SIZE
A4

UNITS
MM[INCH]

GENERAL TOLERANCES
UNLESS SPECIFIED

APPROVED BY:
Geoffrey.Song

PART NO.:
WHSFP0524D003

SACLE
1:1

REV
A0

$x \pm 0.35$
 $.x \pm 0.30$

$x^\circ \pm 3.0^\circ$
 $.x^\circ \pm 2.0^\circ$

CHECKED BY:
Elvis.Song

REMARK:
gold plated 15u"

SHEET
2/4



$.xx \pm 0.25$
 $.xxx \pm 0.10$

$.xx^\circ \pm 1.5^\circ$
 $.xxx^\circ \pm 1.0^\circ$

DESIGND BY:
Sunny.Xu

TEL: +86 400 1048 018

WEB: WWW.WOHU-TEK.COM

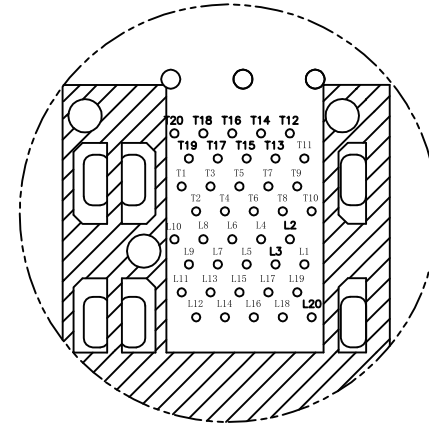
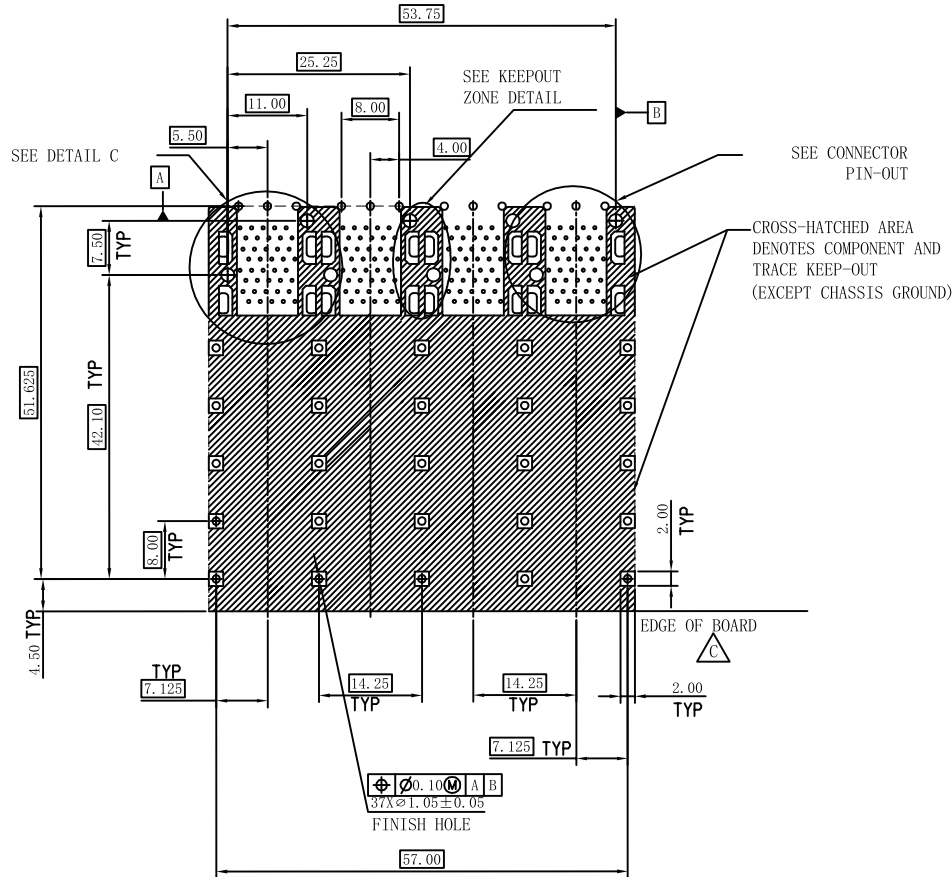

CONNECTOR PIN-OUT
COMPONENT SIDE OF BOARD

RECOMMENDED PCB LAYOUT-COMPONENT SIDE
RECOMMENDED PCB THICKNESS-2.63MM

THE ENTIRE AREA OF THE CONNECTOR FOOTPRINT
TO BE CONSIDERED THE KEEP OUT AREA FOR COMPONENTS
(OTHER THAN LIGHT PIPE LED'S)
THIS AREA IS INDICATED BY THE DASHED LINE

RoHS Compliant

VOOHU 苏州沃虎电子科技有限公司
Su Zhou Voohu Electronic Tech.Co.Ltd

TITLE:
SFP 2X4 CONNECTOR

SIZE
A4

UNITS
MM[INCH]

GENERAL TOLERANCES
UNLESS SPECIFIED

APPROVED BY:
Geoffrey.Song

PART NO.:
WHSFP0524D003

SACLE
1:1

REV
A0

$x \pm 0.35$ $x^\circ \pm 3.0^\circ$
 $.x \pm 0.30$ $.x^\circ \pm 2.0^\circ$

CHECKED BY:
Elvis.Song

REMARK:
gold plated 15u"

SHEET
3/4

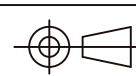

$.xx \pm 0.25$ $.xx^\circ \pm 1.5^\circ$
 $.xxx \pm 0.10$ $.xxx^\circ \pm 1.0^\circ$

DESIGND BY:
Sunny.Xu

TEL: +86 400 1048 018

WEB: WWW.WOHU-TEK.COM

CUSTOMER DRAWING

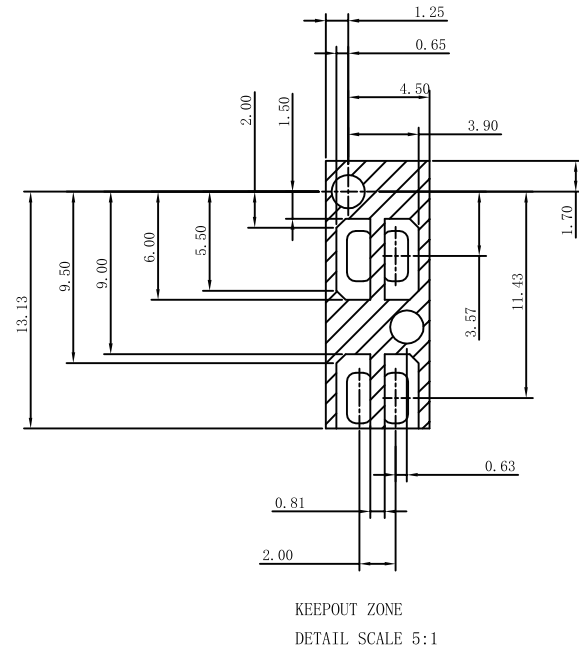
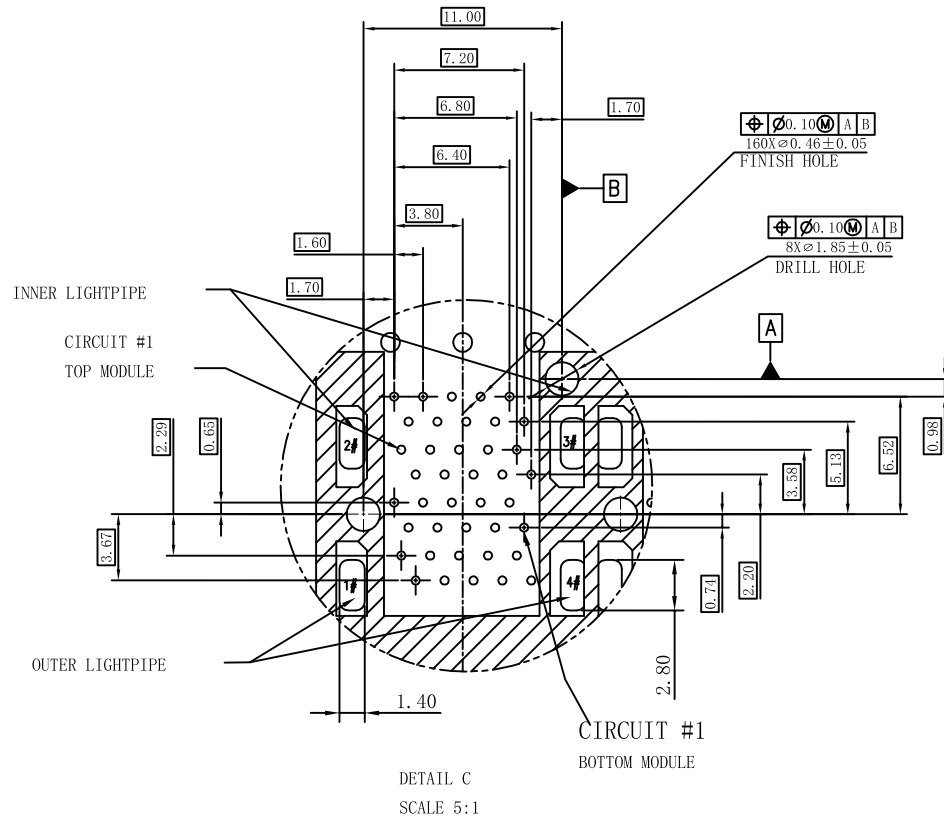

RoHS Compliant

VOOHU 苏州沃虎电子科技有限公司
Su Zhou Voohu Electronic Tech.Co.Ltd

TITLE:
SFP 2X4 CONNECTOR

SIZE
A4

UNITS
MM[INCH]

GENERAL TOLERANCES
UNLESS SPECIFIED

APPROVED BY:
Geoffrey.Song

PART NO.:
WHSFP05524D003

SACLE
1:1

REV
A0

$x \pm 0.35$	$x^\circ \pm 3.0^\circ$
$.x \pm 0.30$	$.x^\circ \pm 2.0^\circ$

CHECKED BY:
Elvis.Song

REMARK:
gold plated 15u"

SHEET
4/4

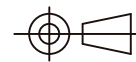

$.xx \pm 0.25$	$.xx^\circ \pm 1.5^\circ$
$.xxx \pm 0.10$	$.xxx^\circ \pm 1.0^\circ$

DESIGND BY:
Sunny.Xu

TEL: +86 400 1048 018

WEB: WWW.WOHU-TEK.COM