

REACH & RoHS
COMPLIANT

1 Features And Benefits

- High common mode impedance at high frequency effects excellent noise suppression performance
- 55uH~60uH are optional for different noise level and signal frequency
- Suppression of Common Mode Noise Without Attenuating The Signal
- High-Quality Product That Uses Auto Winding
- Operating temperature -40°C to +105°C
- Available in 3216(1206) Size
- RoHS Compliant

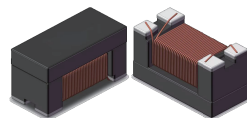

3 Dimensions (mm)& recommend layout

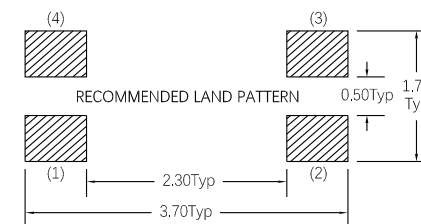
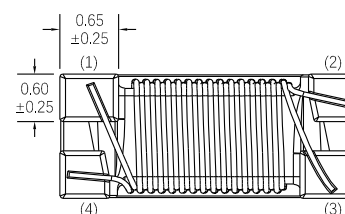
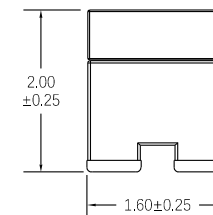
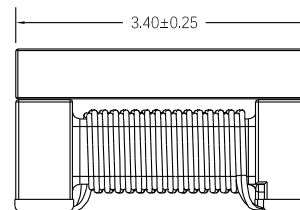

2 Electrical Specifications @ 25°C

1G Base-T

Part Number	Inductance 100KHz/0.1V (μH)Min	DC Resistance (Ω MAX)	Rated Voltage (Vdc)	Rated Current (mA MAX)	Withstanding Voltage (Vdc)	Insulation Resistance (MΩ MIN)
WHLC-3216A-600M0	60	1.70	50	200	125	10

2.5G Base-T

Part Number	Inductance 100KHz/0.1 V (μH)Min	Insertion Loss 1-125MHz (dB)Typ	Return Loss 1-125MHz (dB)Typ	DC Resistance (Ω MAX)	Rated Voltage (Vdc)	Rated Current (mA MAX)	Withstandin g Voltage (Vdc)	Insulation Resistance (MΩ MIN)
WHLC-3216A-550M0	55	-1.0	-15.0	1.50	50	200	125	10

4 Schematics

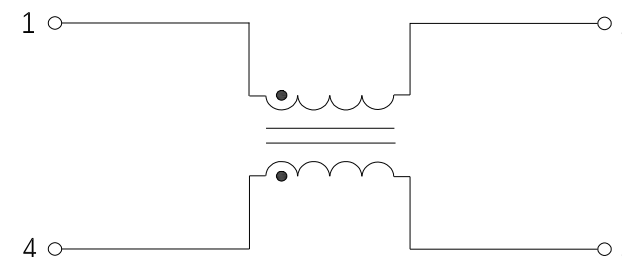

TITLE:
Common Mode Choke

SIZE
A4

UNITS
MM[INCH]

GENERAL TOLERANCES
UNLESS SPECIFIED

APPROVED BY:
Geoffrey.Song

PART NO.:
WHLC-3216A-600M0

SACLE
1:1

REV
A0

x±0.35 x°±3.0°
.x±0.30 .x°±2.0°

CHECKED BY:
Elvis.Song

TEL: +86 400 1048 018

WEB: WWW.WOHU-TEK.COM

REMARK:
1G/2.5GAuto-Transfomer

SHEET
1/3

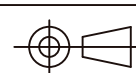

.xx±0.25 .xx°±1.5°
.xxx±0.10 .xxx°±1.0°

DESIGND BY:
Sunny.Xu

REACH & RoHS
COMPLIANT

5 Impedance VS. Frequency

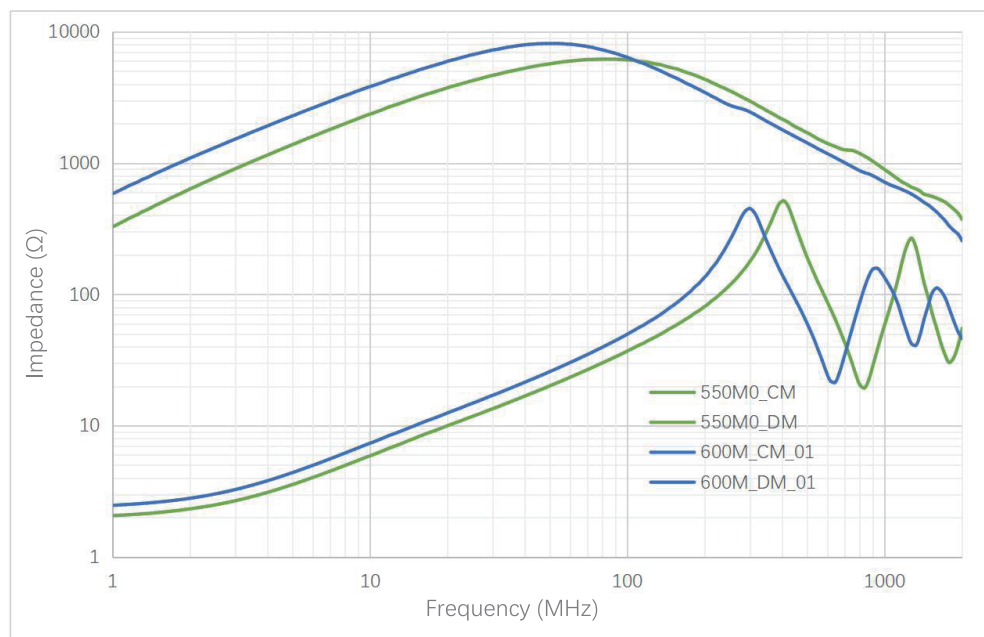

6 Recommended Reflow Profile

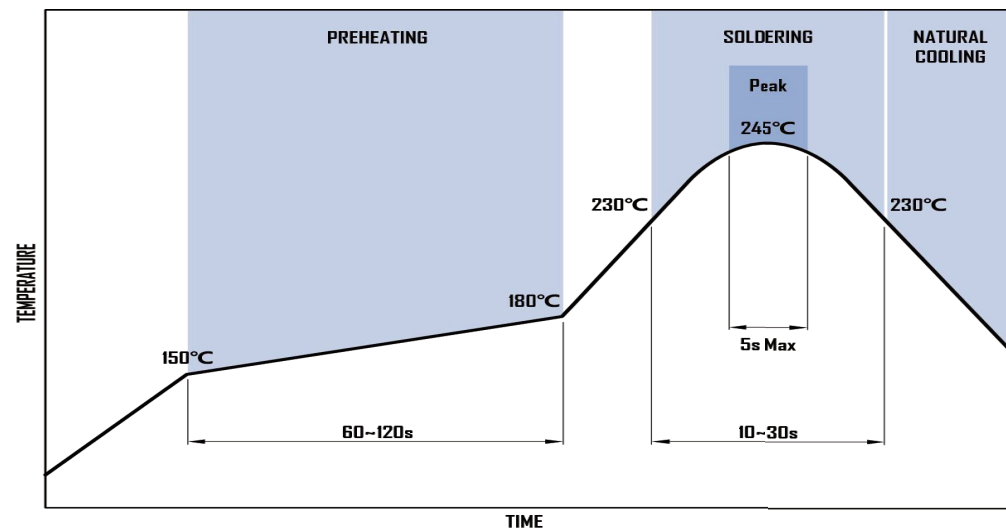

VOOHU 苏州沃虎电子科技有限公司
Su Zhou Voohu Electronic Tech.Co.Ltd

TITLE:
Common Mode Choke

SIZE
A4

UNITS
MM[INCH]

GENERAL TOLERANCES
UNLESS SPECIFIED

APPROVED BY:
Geoffrey.Song

PART NO.:
WHLC-3216A-600M0

SACLE
1:1

REV
A0

$x \pm 0.35$
 $.x \pm 0.30$

$x^\circ \pm 3.0^\circ$
 $.x^\circ \pm 2.0^\circ$

CHECKED BY:
Elvis.Song

TEL: +86 400 1048 018

WEB: WWW.WOHU-TEK.COM

REMARK:
1G/2.5GAuto-Transformer

SHEET
2/3



$.xx \pm 0.25$
 $.xxx \pm 0.10$

$.xx^\circ \pm 1.5^\circ$
 $.xxx^\circ \pm 1.0^\circ$

DESIGND BY:
Sunny.Xu

REACH & RoHS
COMPLIANT

7 Packaging specification

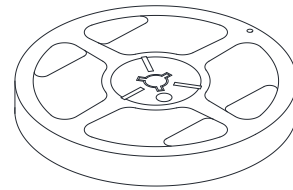
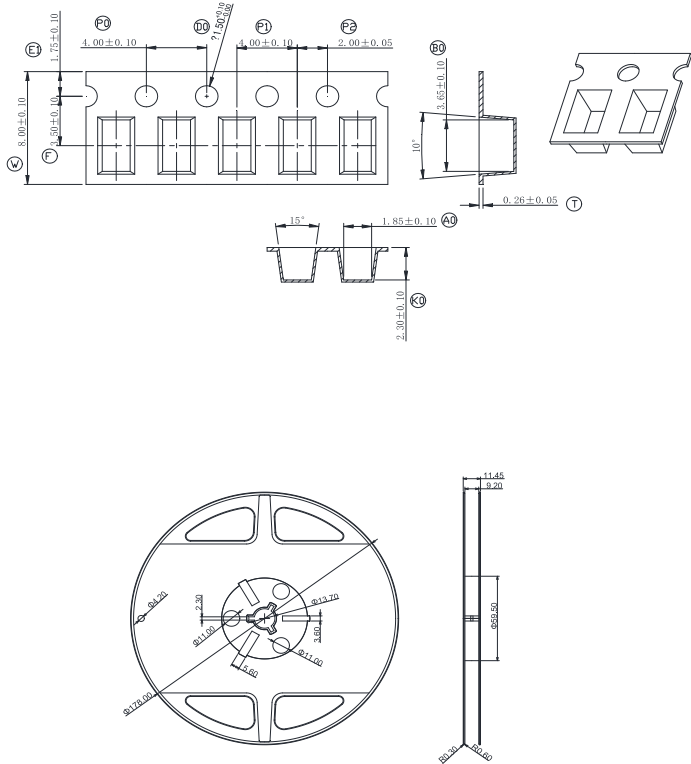

Five Reel



One Cartridge



Four Cartridge

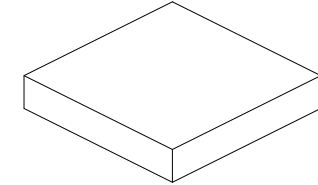

One Inner Carton

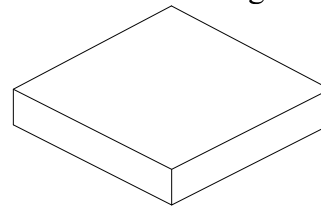

Four Inner Carton

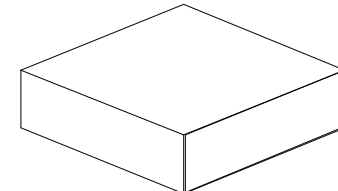

One Export Carton

Package Quantity:
 One Reel=2K Pcs
 One Cartridge=2K*5=10K Pcs
 One Inner Carton=10K*4=40K Pcs
 One Export Carton=40K*4=160K Pcs

VOOHU 苏州沃虎电子科技有限公司
 Su Zhou Voohu Electronic Tech.Co.Ltd

TITLE:
 Common Mode Choke

SIZE
 A4
 UNITS
 MM[INCH]

GENERAL TOLERANCES
 UNLESS SPECIFIED

APPROVED BY:
 Geoffrey.Song

PART NO.:
 WHLC-3216A-600M0

SACLE
 1:1
 REV
 A0

$x \pm 0.35$
 $x^\circ \pm 3.0^\circ$
 $.x \pm 0.30$
 $.x^\circ \pm 2.0^\circ$

CHECKED BY:
 Elvis.Song

TEL: +86 400 1048 018

WEB: WWW.WOHU-TEK.COM

REMARK:
 1G/2.5GAuto-Transfomer

SHEET
 3/3



$.xx \pm 0.25$
 $.xx^\circ \pm 1.5^\circ$
 $.xxx \pm 0.10$
 $.xxx^\circ \pm 1.0^\circ$

DESIGND BY:
 Sunny.Xu