

REACH & RoHS
COMPLIANT

1 Features And Benefits

- Very low DC resistance.
- Different turns ratios.
- Small SMD package.
- Operating temperature range -40 °C to 125 °C.
- Switching power supplies.
- Feedback control.
- Overload sensing.
- Load drop/shut down detection.
- RoHS Compliant

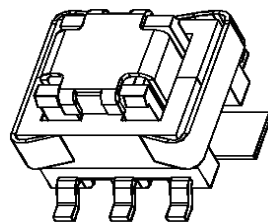

3 Schematics

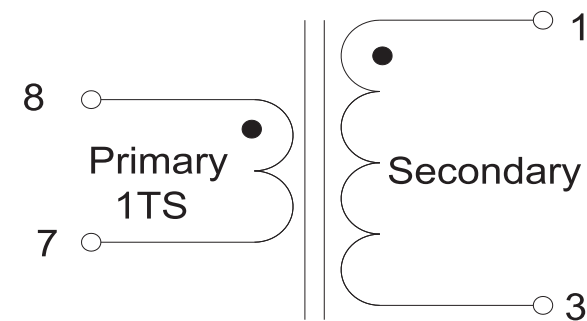

● START POIN

2 Electrical Specifications @ 25°C

Part Number	Secondary Inductance (μH) Min 100KHz,0.1V	Current Rating (A) Max	Turns Ratio	DCR (mΩ)		Hipot (V _{DC})
				Max	Max	
				Primary	Secondary	
WHPT-EE050-003	80	20	1:20	0.75	400	1000
WHPT-EE050-004	180	20	1:30	0.75	870	1000
WHPT-EE050-005	320	20	1:40	0.75	1140	1000
WHPT-EE050-006	500	20	1:50	0.75	1500	1000
WHPT-EE050-007	720	20	1:60	0.75	1980	1000
WHPT-EE050-008	980	20	1:70	0.75	3000	1000
WHPT-EE050-009	2000	20	1:100	0.75	5500	1000
WHPT-EE050-010	3000	20	1:125	0.75	6500	1000
WHPT-EE050-011	8000	20	1:200	0.75	33240	1000

VOOHU 苏州沃虎电子科技有限公司
Su Zhou Voohu Electronic Tech.Co.Ltd

TITLE:
SMT Current Sense Transformers

SIZE
A4
UNITS
MM[INCH]

GENERAL TOLERANCES
UNLESS SPECIFIED

APPROVED BY:
Geoffrey.Song

PART NO.:
WHPT-EE050-010

SACLE
1:1

REV
A0

x±0.35	x°±3.0°
.x±0.30	.x°±2.0°

CHECKED BY:
Elvis.Song

TEL: +86 400 1048 018

WEB: WWW.WOHU-TEK.COM

REMARK:
50K---1 MHz Available

SHEET
1/3



.xx±0.25	.xx°±1.5°
.xxx±0.10	.xxx°±1.0°

DESIGND BY:
Sunny.Xu

REACH & RoHS
COMPLIANT

4 Dimensions (mm)& recommend layout

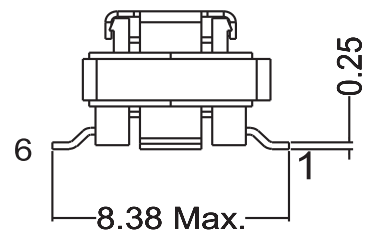

Front view

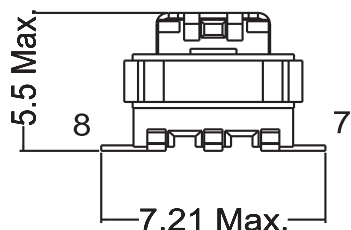

Side view

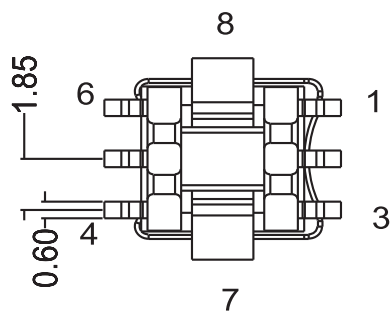

Bottom view

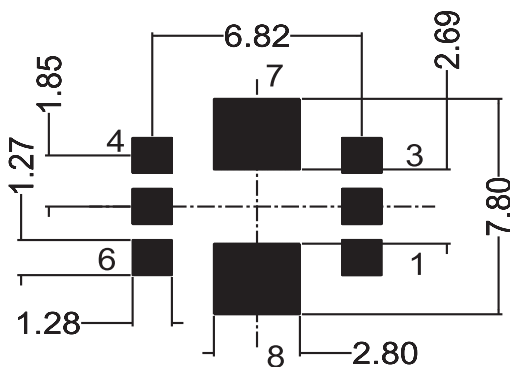

Suggested PAD Layout

5 Recommended Reflow Profile

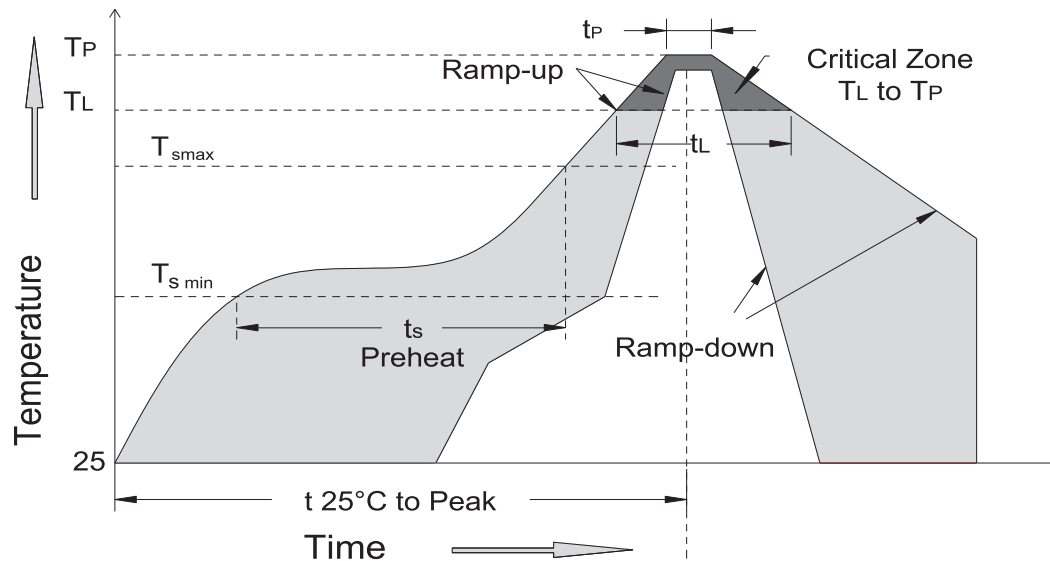

MSL:

Grade: 1 level. Floor life: 0.5 year Condition: $\leq 30^{\circ}\text{C}/60\%\text{RH}$.

Ramp up rate= $3^{\circ}\text{C}/\text{s}$ max Ramp down rate= $6^{\circ}\text{C}/\text{s}$ max

TL= 217°C tL=60s-150s Tp= $250\pm 3^{\circ}\text{C}$ Time within 5°C of actual Peak Temperature (tp): 20~40s

Ts min= 150°C Ts max= 200°C Ts min to Ts max: 60s-180s, 25°C to peak Temperature: 8minutes max

VOOHU 苏州沃虎电子科技有限公司
Su Zhou Voohu Electronic Tech.Co.Ltd

TITLE:
SMT Current Sense Transformers

SIZE
A4 UNITS
MM[INCH]

GENERAL TOLERANCES
UNLESS SPECIFIED

APPROVED BY:
Geoffrey.Song

PART NO.:
WHPT-EE050-010

SACLE
1:1 REV
A0

$x\pm 0.35$ $x^{\circ}\pm 3.0^{\circ}$
 $.x\pm 0.30$ $.x^{\circ}\pm 2.0^{\circ}$

CHECKED BY:
Elvis.Song

REMARK:
50K---1 MHz Available

SHEET
2/3



$.xx\pm 0.25$ $.xx^{\circ}\pm 1.5^{\circ}$
 $.xxx\pm 0.10$ $.xxx^{\circ}\pm 1.0^{\circ}$

DESIGND BY:
Sunny.Xu

TEL: +86 400 1048 018

WEB: WWW.WOHU-TEK.COM

REACH & RoHS
COMPLIANT

6 Packaging specification

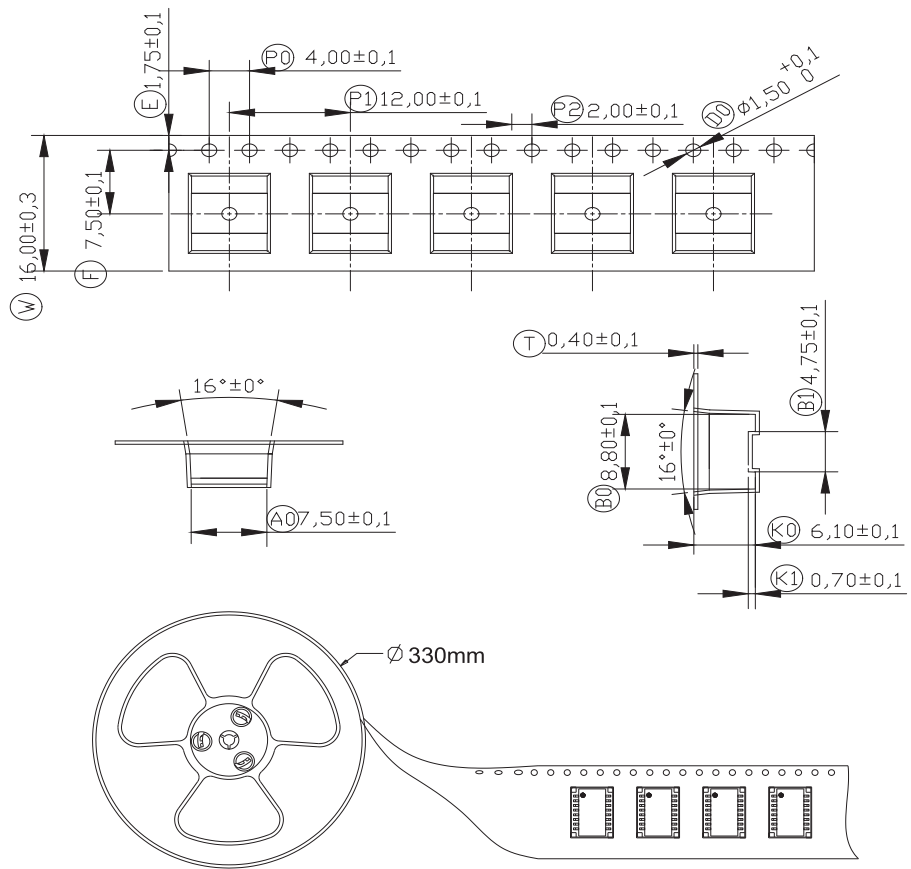

Four Reel

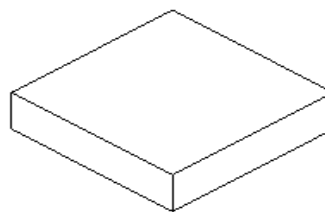

Two Inner Carton

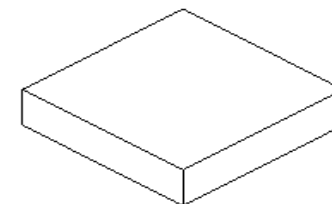

Inner Carton

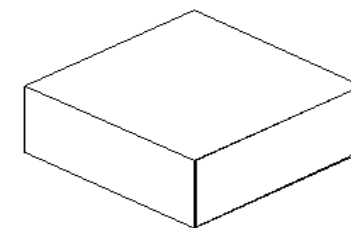

Export Carton

Package Quantity:
 One Reel=850 Pcs
 One Inner Carton=850*4=3400 Pcs
 One Export Carton=3400*2=6800 Pcs

VOOHU 苏州沃虎电子科技有限公司
 Su Zhou Voohu Electronic Tech.Co.Ltd

TITLE:
SMT Current Sense Transformers

SIZE
A4

UNITS
MM[INCH]

GENERAL TOLERANCES
UNLESS SPECIFIED

APPROVED BY:

PART NO.:
WHPT-EE050-010

SACLE
1:1

REV
A0

x±0.35
.x±0.30
.xx±0.25
.xxx±0.10

x°±3.0°
.x°±2.0°
.xx°±1.5°
.xxx°±1.0°

CHECKED BY:

Elvis.Song

DESIGN BY:

Sunny.Xu

REMARK:
50K---1 MHz Available

SHEET
3/3



TEL: +86 400 1048 018

WEB: WWW.WOHU-TEK.COM